

**1**<sup>st</sup>  
Edition

# The STP Guide

Design, Operation and Maintenance



**Ananth S Kodavasal, Ph.D.**

Published by:  
**Karnataka State Pollution Control Board**

# The STP Guide

Design, Operation and Maintenance

**Author** Dr. Ananth S. Kodavasal  
**Editor** Nagesh  
**Illustrator** Nagesh  
**Publisher** Karnataka State Pollution Control Board,  
Bangalore, India

# Contents

## The STP Guide – Design, Operation and Maintenance, First Edition

Copyright © 2011 by Karnataka State Pollution Control Board (KSPCB), Bangalore, India.

All rights reserved.

This book exists in two different forms: print and electronic (pdf file).

- An electronic copy of this book can be freely downloaded from the websites authorized by KSPCB.
- Printed copies of this book are available at a nominal price through all KSPCB offices; and its head-office at the address provided below.

Permission is granted to make copies of this book and re-distribute them; provided that these copies are not sold for profit.

### Disclaimer:

No patent liability is assumed with respect to the use of the information contained herein.

Although every precaution has been taken in the preparation of this book, the publisher and author assume no responsibility for errors or omissions; Nor is any liability assumed for damages resulting from the use of the information contained herein.

This book is meant to enlighten and guide the target audiences. The checklists and calculations in this book are designed to provide a reference for assessing the STP. However, in case of a commercial/regulatory dispute, further interpretation and analysis by professional expert may be required. This is desired in light of alternative design approaches that achieve the same desired result, or the presence of other factors that may mitigate an apparent deficiency.

The reader is cautioned that this book explains a typical STP design based on the "Extended Aeration Activated Sludge Process". The underlying principles and/or the calculations may not be fully applicable to STPs of other types, including STPs that are based on a modified/hybrid approach.

No warranty of fitness is implied: The information is being provided on an "as is" basis.

Wastewater treatment is a fast-developing field in India. At present, there is a lot of churn, as many of the new entrant technologies are found to be unsuited to the existing constraints in Indian cities and apartments. Thus with passage of time, the state of technology is expected to be more advanced as compared to the book. The author/editor assume no responsibility to keep the book current with the fast-changing scenario. Although it is envisaged that subsequent revisions of this book will reflect the changes in general, it would be impossible to characterize the vast variations possible in the basic design at any given point of time.

### Contact:

To obtain any kind of clarifications or permissions, please contact -

The PRO/PIO, Karnataka State Pollution Control Board,  
"Parisara Bhavan", #49, Church Street  
Bangalore- 560 001, INDIA.  
email: ho@kspcb.gov.in

### Author

Dr. Ananth S Kodavasal

### Editor

Nagesh

### Illustrator

Nagesh

### DTP & Layout

Prasun Banerjee

### Publisher



KSPCB

<b>Foreword</b> .....	<b>11</b>
<b>Preface</b> .....	<b>13</b>
<b>Acknowledgements</b> .....	<b>15</b>
<b>How to Use This Book</b> .....	<b>17</b>
<b>Background</b> .....	<b>19</b>
The Operating Principle of STPs . . . . .	21
Typical Process in an STP . . . . .	23
Benefits of a well-run STP . . . . .	24
<b>Understanding the STP Stages</b> .....	<b>27</b>
<b>Bar Screen Chamber</b> .....	<b>28</b>
1.1 Function . . . . .	28
1.2 How It Works . . . . .	28
1.3 Design Criteria . . . . .	29
1.4 Construction And Engineering . . . . .	29
1.5 Operation And Maintenance Considerations . . . . .	29
1.6 Troubleshooting . . . . .	29
<b>Oil And Grease/Grit Trap</b> .....	<b>30</b>
2.1 Function . . . . .	30
2.2 How It Works . . . . .	30
2.3 Design Criteria . . . . .	31
2.4 Construction And Engineering . . . . .	31
2.5 Operation And Maintenance Considerations . . . . .	31
2.6 Troubleshooting . . . . .	31
<b>Equalization Tank</b> .....	<b>32</b>
3.1 Function . . . . .	32
3.2 How It Works . . . . .	32
3.3 Design Criteria . . . . .	33
3.4 Construction And Engineering . . . . .	34
3.5 Operation And Maintenance Considerations . . . . .	35

3.6	Troubleshooting . . . . .	35
<b>Raw Sewage Lift Pumps . . . . .</b>		<b>36</b>
4.1	Function . . . . .	36
4.2	How It Works. . . . .	36
4.3	Design Criteria . . . . .	37
4.4	Construction And Engineering . . . . .	37
4.5	Operation And Maintenance Considerations. . . . .	38
4.6	Troubleshooting . . . . .	39
<b>Aeration Tank . . . . .</b>		<b>40</b>
5.1	Function . . . . .	40
5.2	How it works . . . . .	40
5.3	Design Criteria . . . . .	41
5.4	Construction And Engineering . . . . .	42
5.5	Operation And Maintenance Considerations. . . . .	43
5.6	Troubleshooting . . . . .	44
<b>Secondary Clarifier/Settling Tank . . . . .</b>		<b>46</b>
6.1	Function . . . . .	46
6.2	How It Works. . . . .	46
6.2.1	Settling tank with air-lift pump . . . . .	46
6.2.2	Settling tank with direct-suction electric pump . . . . .	48
6.2.3	Settling tank with buffer sump . . . . .	50
6.2.4	Mechanized Clarifier Tank . . . . .	52
6.3	Design Criteria . . . . .	55
6.4	Construction And Engineering . . . . .	55
6.5	Operation And Maintenance Considerations. . . . .	56
6.6	Troubleshooting . . . . .	56
<b>Sludge Recirculation . . . . .</b>		<b>58</b>
7.1	Function . . . . .	58
7.2	How It Works. . . . .	58
7.3	Design Criteria . . . . .	59
7.4	Construction And Engineering . . . . .	59
7.5	Operation And Maintenance Considerations. . . . .	60
7.6	Troubleshooting . . . . .	60
<b>Clarified Water Sump . . . . .</b>		<b>61</b>

8.1	Function . . . . .	61
8.2	Design Criteria . . . . .	61
8.3	Construction And Engineering . . . . .	61
8.4	Operation And Maintenance Considerations. . . . .	61
8.5	Troubleshooting . . . . .	61
<b>Filter Feed Pumps (FFP) . . . . .</b>		<b>62</b>
9.1	Function . . . . .	62
9.2	Design Criteria . . . . .	62
9.3	Construction And Engineering . . . . .	62
9.4	Operation And Maintenance Considerations. . . . .	62
9.5	Troubleshooting . . . . .	63
<b>Pressure Sand Filter (PSF) . . . . .</b>		<b>64</b>
10.1	Function . . . . .	64
10.2	How It Works. . . . .	64
10.3	Design Criteria . . . . .	65
10.4	Construction And Engineering . . . . .	65
10.5	Operation And Maintenance Considerations. . . . .	65
10.6	Troubleshooting . . . . .	65
<b>Activated Carbon Filter (ACF) . . . . .</b>		<b>66</b>
11.1	Function . . . . .	66
11.2	How It Works. . . . .	66
11.3	Design Criteria . . . . .	66
11.4	Construction And Engineering . . . . .	67
11.5	Operation And Maintenance Considerations. . . . .	67
11.6	Troubleshooting . . . . .	67
<b>Disinfection Of Treated Water . . . . .</b>		<b>69</b>
12.1	Function . . . . .	69
12.2	Design Criteria . . . . .	69
11.3	Construction And Engineering . . . . .	69
12.4	Operation And Maintenances Considerations . . . . .	69
12.5	Troubleshooting . . . . .	69
<b>Excess Sludge Handling . . . . .</b>		<b>70</b>
13.1	Function . . . . .	70

13.2	Design Criteria . . . . .	70
13.3	Construction And Engineering . . . . .	70
13.3.1	Plate-and-Frame Filter press . . . . .	70
13.3.2	Bag-type dewatering . . . . .	72
13.4	Operation And Maintenance Considerations. . . . .	73
13.5	Troubleshooting . . . . .	74
	<b>Miscellaneous Considerations . . . . .</b>	<b>75</b>
	<b>Design and Engineering . . . . .</b>	<b>77</b>
	<b>STP Design Process . . . . .</b>	<b>78</b>
	Design process overview . . . . .	78
	Design Criteria for STP. . . . .	80
	Sewage Quantity (STP Capacity) . . . . .	82
	Bar Screen Chamber. . . . .	83
	Equalization Tank . . . . .	84
	Raw Sewage Lift Pumps . . . . .	84
	Aeration Tank. . . . .	85
	Clarifier Tank . . . . .	88
	Airlift Pump. . . . .	90
	Electric Pumps for Return Sludge . . . . .	90
	Sludge-holding sump. . . . .	90
	Pressure Sand Filter . . . . .	91
	Activated Carbon Filter. . . . .	92
	Sodium Hypo Dosing System . . . . .	93
	Sludge-Handling System. . . . .	94
	<b>Engineering checks for the STP . . . . .</b>	<b>96</b>
	Preparation. . . . .	96

Bar Screen . . . . .	97
Equalization tank . . . . .	99
Raw Sewage Lift Pumps . . . . .	100
Aeration tank . . . . .	102
Secondary settling tank (Hopper-bottom) . . . . .	104
Secondary Clarifier tank (mechanized, with rake) . . . . .	106
Sludge Recirculation pumps-Airlift . . . . .	110
Sludge Recirculation pumps-Electric. . . . .	110
Sludge Recirculation system-Direct suction . . . . .	111
Sludge Recirculation system- With a buffer sump . . . . .	111
Clarified water tank. . . . .	112
Filter feed Pumps . . . . .	112
Backwash pumps . . . . .	114
Pressure Sand Filter . . . . .	114
Activated Carbon filter . . . . .	116
Disinfection system . . . . .	119
Sludge-Handling system . . . . .	119
Air Blowers . . . . .	120
MISC . . . . .	122
<b>Operational checks for the STP . . . . .</b>	<b>126</b>
Preparation. . . . .	126
Bar Screen Chamber . . . . .	127
Equalization tank . . . . .	127
Raw Sewage Lift Pumps . . . . .	128
Aeration tank . . . . .	128
Secondary settling tank (Hopper-bottom). . . . .	130

Secondary Clarifier tank (mechanized, with rake) . . . . .	130
Sludge Recirculation pumps-Airlift . . . . .	131
Sludge Recirculation pumps-Electric . . . . .	131
Sludge Recirculation system-Direct suction . . . . .	132
Sludge Recirculation system- With a buffer sump . . . . .	132
Clarified water tank. . . . .	132
Filter feed Pumps . . . . .	133
Backwash pumps . . . . .	133
Pressure Sand Filter. . . . .	133
Activated Carbon filter . . . . .	134
Disinfection system . . . . .	134
Sludge-Handling system . . . . .	134
Air Blowers . . . . .	134
MISC . . . . .	135
<b>Appendices . . . . .</b>	<b>137</b>
Managing the Microbes . . . . .	138
MLSS . . . . .	139
Glossary . . . . .	140
About the Author. . . . .	142



## KARNATAKA STATE POLLUTION CONTROL BOARD

ಕರ್ನಾಟಕ ರಾಜ್ಯ ಮಾಲಿನ್ಯ ನಿಯಂತ್ರಣ ಮಂಡಳಿ

"Parisara Bhavan"  
49, Church Street,  
Bangalore - 560 001.  
Ph : 080-25588151  
Fax : 080-25588782  
Res : 080-25262292

Email : [chairman@kspcb.gov.in](mailto:chairman@kspcb.gov.in)  
Website : <http://kspcb.gov.in>

**A.S. Sadashivaiah**, IFS (Retd.)  
Chairman

### FOREWORD

From protecting the Forests to protecting the Environment was just a short step in backward integration, or so I thought. From being the Principal Chief Conservator of Forests to becoming the Chairman of the Karnataka State Pollution Control Board was certainly a step up for me : Forests and the Environment share a reciprocal cause and effect relationship. Protect the one, you protect the other. Only the Environment is a different kind of Beast – a many headed Hydra.

Of the three principal aspects of the Environment – Water, Air and Soil, the one crying for immediate attention in the metropolis of Bangalore, and indeed other cities and towns of India is the inescapable imperative to conserve water, treat wastewater, renovate, recycle and reuse. I am convinced that this Mantra results in enormous intangible benefits to public health for this generation and the ones to come. Dr. Ananth S Kodavasal has convinced me even more forcefully of the astounding economic benefits that accrue directly in monetary terms of return on investment, if a Sewage Treatment Plant is operated successfully.

Dr. Kodavasal, tutored under the legendary Prof. W.W. Eckenfelder at Vanderbilt University is a firm votary of his mentor's maxim : "Wastewater Treatment is an Art, not Science". He is also a staunch proponent of the Three Cardinal Rules theory for a good Treatment Plant :

- Proper Design
- Proper Engineering
- Proper Operation & Maintenance

This Guidebook takes the reader through the various units, operations and processes in a typical Extended Aeration Biological treatment plant, the Workhorse of the industry. The treatment proceeds in a logical and linear progression from the first unit – the Bar Screen to the final unit for sludge handling and disposal. The three cardinal rules are applied to each unit in a simple enough manner that makes reading of the book easy, and the learning to be fun, with splendid 3D colour illustrations of the various units in a Treatment Plant. At the end of the book are self use and evaluation sections, where the reader is enabled to navigate through the design and engineering checks for a good Treatment Plant.

This is not a Textbook, full of equations and formulae. It is Practical Guidebook in which Dr. Kodavasal shares with the reader knowledge gained over 30 years as a practicing environmental engineer, in a ready to use format.

Let all of us – Concerned Citizen, Student, Builder, Consultant, Facility Manager, Managing Committee of Apartments, and indeed my own officers, the regulators of Environmental Laws put to practice and good use the lessons learnt from this book. We will be doing ourselves proud conserving a precious natural resource and protecting the Environment : the enormous monetary benefit to be reaped is only the icing on the cake.

Date: 24.08.2011  
Place: Bangalore

# Preface

---

Over five years ago, the Karnataka State Pollution Control Board mandated that Sewage Treatment Plants be built and operated in individual residential complexes having fifty or more dwellings, or generating 50 m<sup>3</sup>/day or more of sewage. Additional conditions imposed among others were that the treated water quality shall meet stringent “Urban Reuse Standards”, treated water shall be reused for toilets flushing (thus requiring dual plumbing system in the residential complexes), for car washing, and for irrigation use within the campus.

For a city like Bangalore, the action of the KSPCB as above comes as a blessing in disguise.

Let me elaborate my viewpoint:

Fresh water is getting scarcer by the day in every part of the Globe. Bangalore as a city finds itself in a precarious position as far as availability of water is concerned, among other essentials for civilized society. Planners and public utilities have abdicated their duty and responsibility to provide one of the basic needs of the citizenry of good, clean water. In the years to come this scenario is only likely to worsen.

More than fifteen years ago, I had recommended to the then Commissioner of the Mahadevapura CMC that the water from Varthur lake could be renovated by employing suitable treatment schemes to supply potable water to the then outlying areas of Bangalore city. This would be much more economical and eminently feasible than the grandiose plans of multiple stages and phases of Cauvery schemes that were being touted. My logic was simple: The river Cauvery, like a majority of all other rivers in the world will continue to be a dwindling source of fresh water. The Varthur lake on the other hand is a perennial source of water (albeit of a lesser quality), carrying the water discharged from millions of homes in Bangalore. In a similar fashion, at other extremities of the city, other such perennial sources of water may be tapped: The Vrishabhavati to the South and the Hebbal valley to the North.

(I shall not go into the pros and cons of decentralized vs. centralized STPs, except to point out that centralized plants will necessarily be under the aegis of the public utilities, and there I rest my case.)

A large residential complex, in its sewage generation potential, may then be viewed as a microcosm of the city itself; with a ready and perennial source of water right at its doorstep. All that the complex needs is to have a good, robust, well designed STP to produce water for all its secondary needs.

Kudos to the KSPCB for taking this initiative!

So, given this already grim and rapidly worsening scenario, it is important for the people living in Bangalore and other mega cities in India to realize the importance of recycled water, and strive to set up efficient water treatment plants within their complexes, so that they can themselves control the quality of the water they use. At the same time, they will also be bringing down their own cost of living substantially, by obviating the laying of huge pipelines that bring water from far-off places.

This book will help them achieve this all important goal.

It is my hope that all of us (legislators, experts, environmentalists and public at large) will make concerted efforts to avert a water crisis of mega proportions.

**Bangalore**

May 2011

**Dr. Ananth S Kodavasal**



# Acknowledgements

---

I owe a deep debt of gratitude to Mr. A.S Sadashivaiah, the Hon'ble Chairman of the KSPCB for providing the impetus for this book, his further encouragement and support by undertaking to publish the book under the aegis of the KSPCB for a worthy public cause.

I would like to thank Dr. D L Manjunath, for reviewing the book and giving his valuable inputs and suggestions. Dr. Manjunath has been a respected academic at the Malnad College of Engineering, Hassan, and the author of a textbook prescribed by the Visvesvaraya Technological University for its degree courses in Environmental Engineering. He has served as Chairman of the Technical Advisory committee of the KSPCB, and has been a member of the high powered State-Level Expert Appraisal committee on environmental impacts of large projects. His achievements in this field are far too numerous to be fully listed in this humble note of thanks.

Special thanks go to senior officers of the KSPCB M/s. M D N Simha, M N Jayaprakash, S Nanda Kumar, K M Lingaraju, and H K Lokesh for their support at various stages in the making of the book.

Much of the credit for making this book a reality goes to my dear friend, Nagesh, who edited the book and also provided illustrations. His keen intellect and a questioning mind ever probing to get to the bottom of every issue big and small made him the perfect foil and indeed a sounding board for me to keep this book simple to read yet convey the essentials of the subject in a comprehensible manner. His illustrations in colour, done painstakingly, truly add value to the book, and break the monotony of technical jargon, while giving flesh and blood and bringing to life otherwise inanimate objects in a sewage treatment plant.

**Dr. Ananth S Kodavasal**

August 15, 2011

# How to Use This Book

---

This booklet is meant to be a primer on a domestic STP (Sewage Treatment Plant).

The design, engineering, operation and maintenance aspects of the various units in the STP are covered.

This book is for you if you belong to one of the following groups:

- For large and small **builders** alike, who generally depend on plumbing consultants for STP designs, this book serves as a reference. They can avoid a lot of costly rework and delayed projects by following the design and engineering recommendations made in this book.
- For the **Managing Committees (and Estate Managers) of an apartment complex**, this book provides both guidelines and checklists for taking over from the builders. It also provides detailed guidance for day-to-day operation and maintenance of STP.
- For the **Facility Managers of factories and large office complexes**, this book will serve as a guide for their daily operation and maintenance.
- For the **officers of a Pollution Control Board**, who may be confronted with a myriad options in design, served up by less-than-competent agencies and individuals, this book provides the core design and engineering principles that must be met. It also lists specific operational, maintenance, safety and ergonomic considerations for each stage of the STP. This should make it easy for an officer to take a nonsubjective decision about acceptability of any plant.
- For the **students of Environmental Engineering**, this booklet will bring a welcome break from their differential equations, and instead take them directly to the end-result of these equations, tempered with a large dose of practical know-how.
- For any **lay person or environmentalist**, this book provides general knowledge on the subject.

Several variants of STP are in use, of which the Extended Aeration Activated Sludge Process model is most prevalent. Therefore this book is focused on this model.

The sections in this book are structured to follow the logical treatment process chain in a typical STP, starting with the Bar Screen, and ending with treated water for flush and drinking purposes. It also has a round up of the final chore: handling of the dewatered sludge.

For each unit of the STP, the following aspects are addressed:

- The basic intended function of each unit
- How a typical unit looks like, and how it works
- Design considerations
- Engineering considerations
- Operation and maintenance aspects
- Troubleshooting chart

The booklet is concise enough to give you a bird's eye view of an STP in a single sitting. But you may also wish to delve deeper into any section of this book to gain greater appreciation of that particular unit of the STP. Take a moment to ponder over the several statements made in each section, and to ask yourself the questions what? how? why? when? You will be surprised to find the answers for yourself with little application of mind. Common sense is indeed the cornerstone of Environmental Engineering!

Note that this book does not claim to be a comprehensive design handbook for all forms of STPs, nor does it venture to compare the relative merits of the various other schemes. Also note that all the figures in this book are for illustrative purpose only; and many details are intentionally omitted to make them simple to understand. Therefore please do not try to construct/modify any of the units based on these figures.

If you would like to send any suggestions for improvements, or any other feedback about this book, you can send a mail to the author at [kodavaas@bgl.vsnl.net.in](mailto:kodavaas@bgl.vsnl.net.in).

# Background

---

A sewage treatment plant (“STP”) has to handle the designed quantity of sewage and deliver satisfactory quality of treated water, on a consistent, sustained basis over typically 10-15 years.

This requires proper design and engineering; followed by proper operation and maintenance throughout its life.

There are as many variations in the design and engineering of an STP as there are permutations and combinations of Builders/ developers, architects, Utility Consultants, Vendors. It cannot be gainsaid then that each of these agencies will have its own set of priorities and constraints which may adversely impinge on the design and engineering of the STP, thereby diluting to various degrees the very function and objective of the STP. Some of these constraints observed in the past on the part of these agencies are:

- Lack of commitment to the environment
- Lack of appreciation of the enormous benefit of recycle and reuse
- Funding constraints
- Lack of necessary knowledge and skill on the part of the designer
- Lack of commitment for proper operation & maintenance
- External pressures, etc.

Certain basic minimum criteria must be followed in the design and engineering of an STP, irrespective of any and all constraints, if the Plant is to deliver its stated objectives.

The following sections outline in brief these basic minimum requirements in terms of design and basic engineering of the various units in the STP.

# The Operating Principle of STPs

First of all, let us understand the underlying concept of a biological sewage treatment plant.

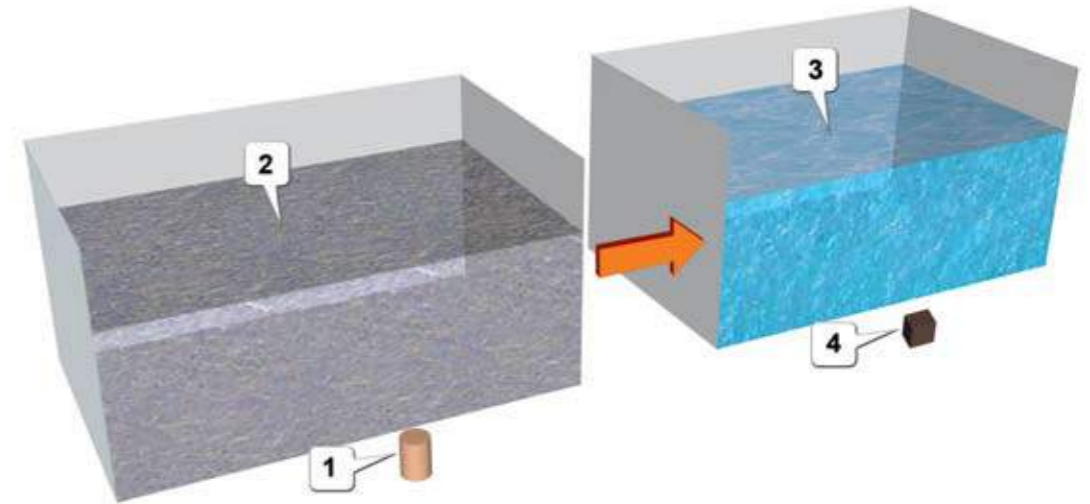

Conceptually, the process is extremely simple: A small amount of microorganisms **1** converts a large mass of polluted water **2** into clean water **3**. This process also produces a co-product: A vastly reduced, compact solid biomass **4** (the excess microorganisms produced by growth and multiplication of the original population of microorganisms).

However, translating this simple principle into a properly designed and engineered STP is a real challenge: It requires sound knowledge of the biology of the microorganisms, chemical and mechanical engineering principles, and an equally large dose of common sense.

We need an STP that-

- Achieves the desired results on a consistent and sustained basis.
- Is robust and reliable, and lasts for at least 10-15 years without major repairs.
- Needs minimum amounts of money, energy and chemicals to achieve the desired treated water quality.
- Is easy to operate and maintain.

This manual provides tips on how to build and operate such an STP.

# Typical Process in an STP

The flow chart of a typical STP is shown below (optional units are shown in yellow).

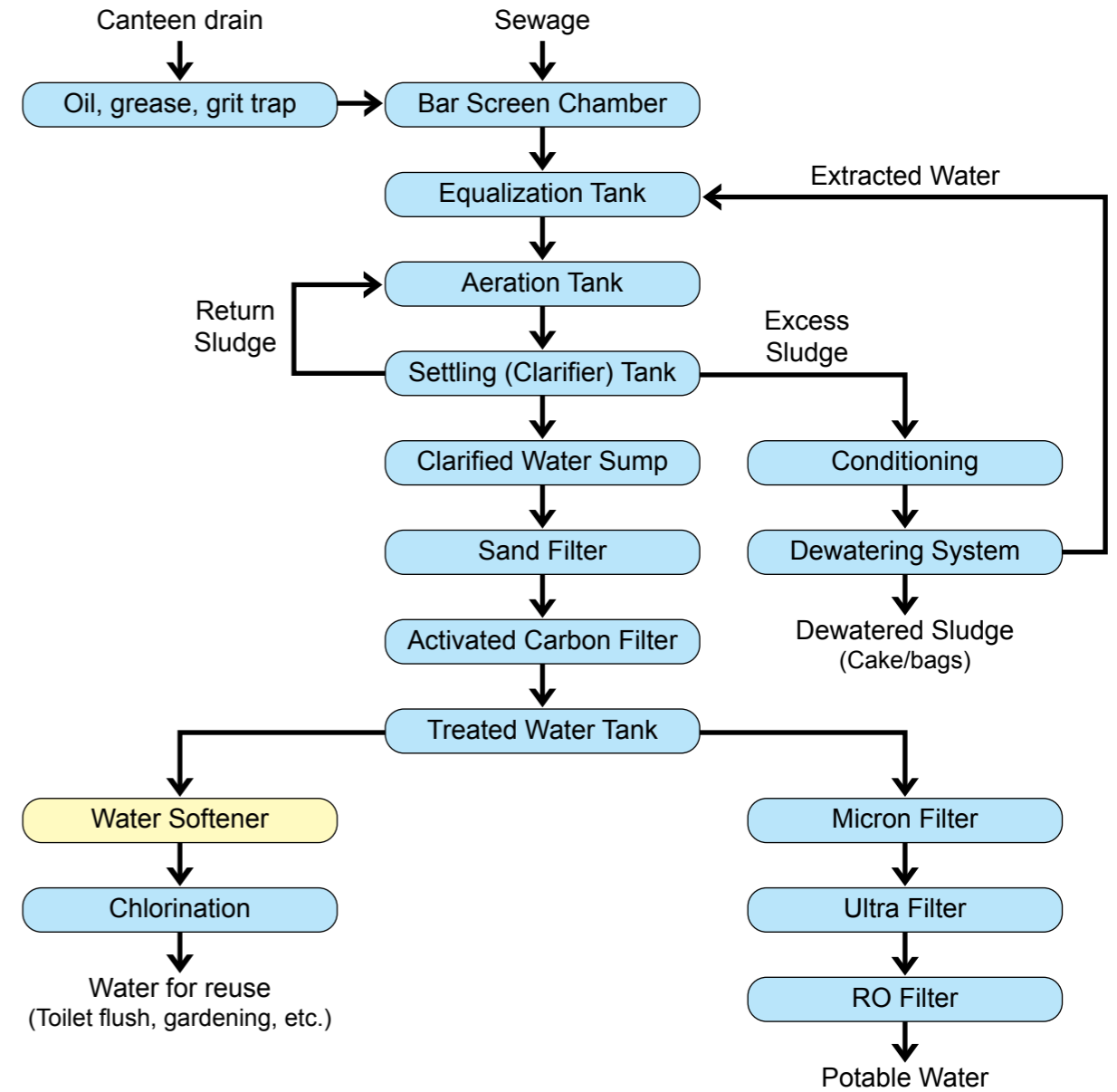

# Benefits of a well-run STP

The primary benefits of a well-run STP are-

- Assured availability of water for various secondary uses
- Enormous savings in fresh water costs<sup>1</sup>
- Lesser Environmental Degradation
- Improved public Health

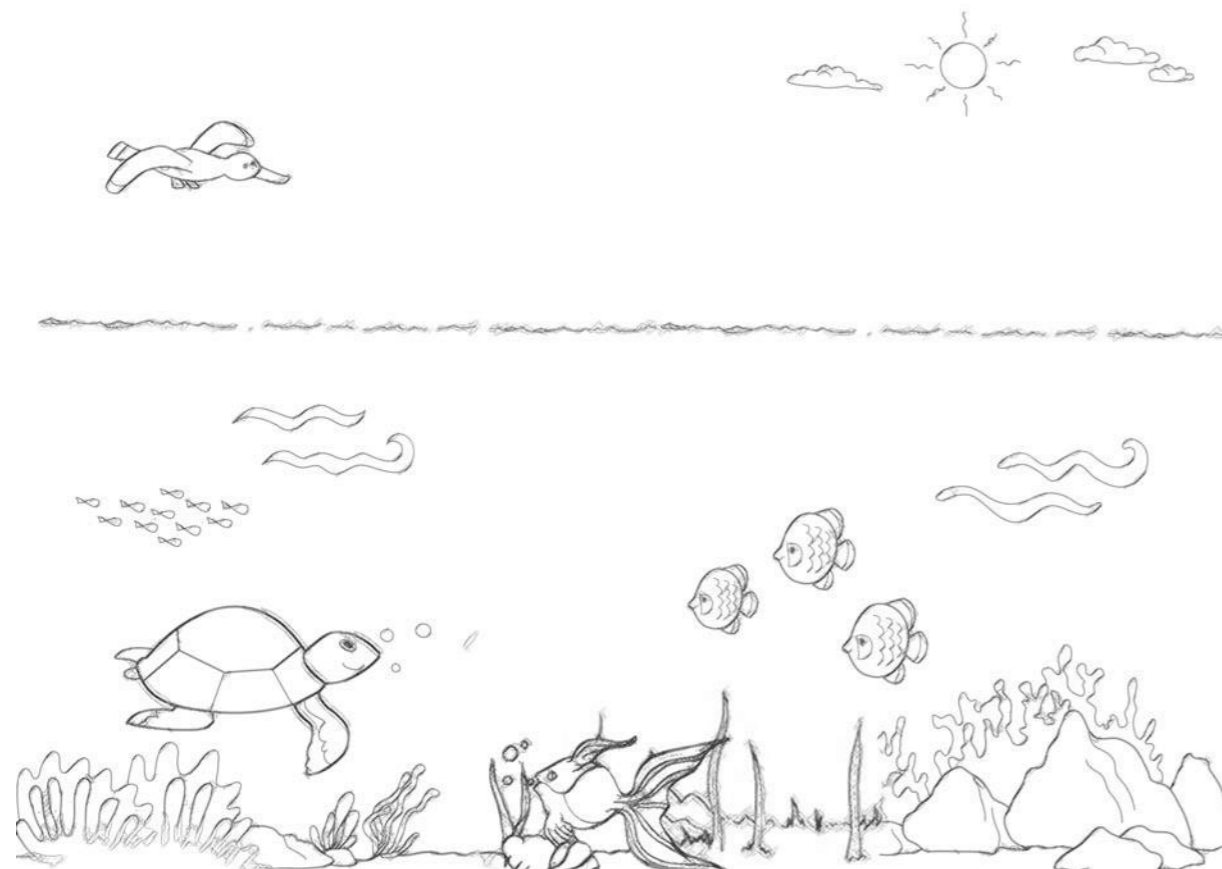

1. The cost of treating water is about Rs. 20~30 per kL (the capital cost of plant is not counted). This means a saving of 50%-70% as compared to buying fresh water.

The following table illustrates the quality of water obtainable from a well-designed, engineered and operated STP at very affordable treatment costs<sup>2</sup>.

Parameter	In raw sewage	After treatment	What it means to you...
pH	6.5-7.5	6.5-7.5	The acidity/alkalinity balance is not affected/alterd.
BOD	200- 250 mg/L	< 10 mg/L	Normally, the biodegradable material in the sewage consumes oxygen when it degrades. If this sewage is released in lakes/river, it would draw naturally dissolved oxygen from water, depleting the oxygen in the lake/river. This causes death of fish and plants. But the STP provides enough oxygen to digest the biodegradable material in sewage. The treated sewage does not need oxygen any longer. Thus it does not affect the aquatic life in lakes and rivers.
Turbidity	Not specified	< 10 NTU <sup>2</sup>	The outgoing treated sewage has low turbidity (suspended particles that cloud the water).  In other words, we get “clear” water.  This prevents the pipelines from getting clogged by settled sediments.  If cloudy water is allowed to reach the lakes and rivers, it blocks the sunlight from reaching the bottom of the water body. This stops the photosynthesis process of the aquatic plants, killing them. That in turns stops generation of oxygen as a byproduct of the photosynthesis process. Depletion of dissolved oxygen in water kills all fish.  Thus low turbidity in discharge water ultimately sustains aquatic life in lakes and rivers.
E. Coli	Not specified	NIL	The STP removes the harmful bacteria completely.

2. Although the KSPCB specifies a limit of 2 NTU, we believe this ought to be relaxed to 10 NTU, which is the limit specified by BIS 10500 – Indian Drinking water Standards.

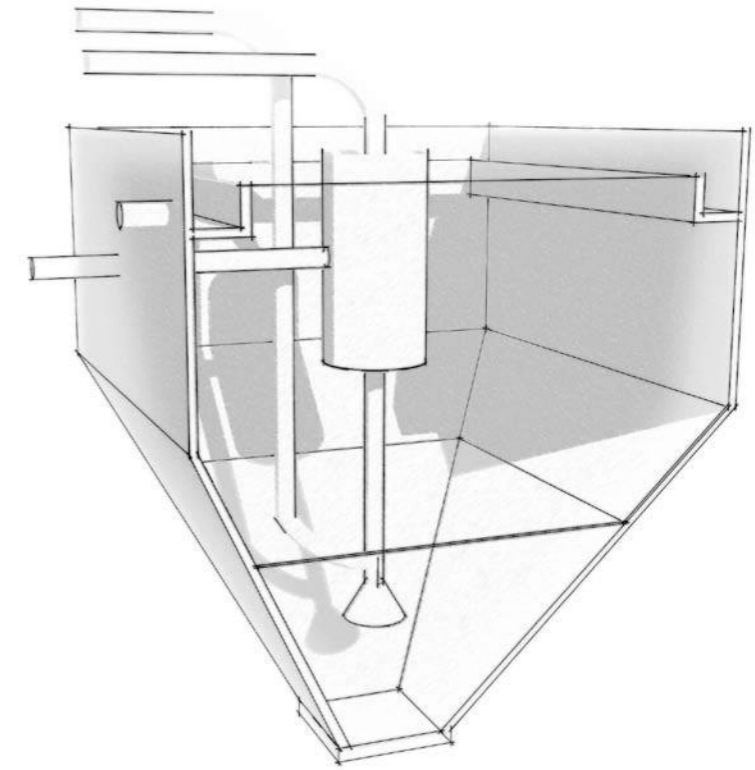

# Understanding the STP Stages

# Bar Screen Chamber

## 1.1 Function

The function of the bar screen is to prevent entry of solid particles/ articles above a certain size; such as plastic cups, paper dishes, polythene bags, condoms and sanitary napkins into the STP. (If these items are allowed to enter the STP, they clog and damage the STP pumps, and cause stoppage of the plant.)

The screening is achieved by placing a screen made out of vertical bars, placed across the sewage flow.

- The gaps between the bars may vary between 10 and 25 mm.
- Larger STPs may have two screens: A **coarse bar screen** with larger gaps between bars, followed by a **fine bar screen** with smaller gaps between bars.
- In smaller STPs, a single **fine bar screen** may be adequate.

If this unit is left unattended for long periods of time, it will generate a significant amount of odor: it will also result in backing of sewage in the incoming pipelines and chambers.

## 1.2 How It Works

A typical Bar Screen Chamber (also called a “Bar Screen Channel”) is shown here (cutaway view).

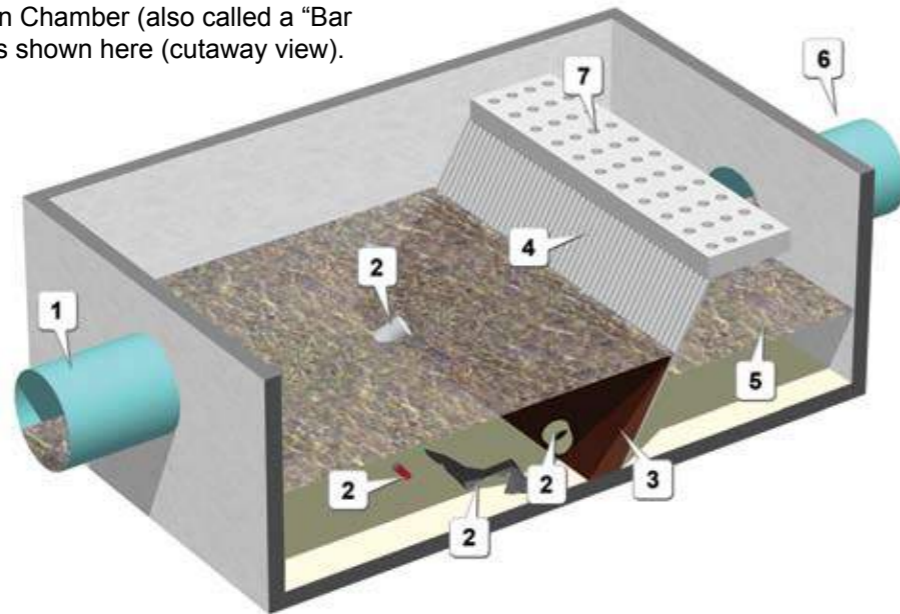

**Note:**

Only the surface of the sewage is shown, so that items submerged in the sewage are visible.

SL	Remarks
1	<b>Inlet pipe</b> for the STP.
2	<b>Debris</b> (plastic bags, paper cups, condoms, sanitary napkins, paper dishes, etc.) gets trapped here.

3	<b>Muck</b> (sediment in sewage) accumulates and blocks the grill (if not cleaned regularly)
4	<b>Grill.</b> Must be cleaned regularly to avoid a build-up of debris (2) and muck (3).

5	<b>Screened sewage.</b> If the screen (4) is maintained well, this would be free of any large articles.
6	<b>Outlet pipe</b> (goes to the Equalization Tank)
7	<b>Platform with weep holes.</b> The STP operator stands here to rake the debris (2). He also uses the platform as a drip-tray for the collected debris.

## 1.3 Design Criteria

The design criteria applies more to the sizing and dimensions of the Screen chamber rather than the screen itself.

1. The screen chamber must have sufficient cross-sectional opening area to allow passage of sewage at peak flow rate (2.5 to 3 times the average hourly flow rate) at a velocity of 0.8 to 1.0 m/s,

(The cross-sectional area occupied by the bars of the screen itself is not to be counted in this calculation.)

2. The screen must extend from the floor of the chamber to a minimum of 0.3 m above the maximum design level of sewage in the chamber under peak flow conditions.

## 1.4 Construction And Engineering

Bar screen racks are typically fabricated out of 25 mm x 6 mm bars either of epoxy-coated mild steel or stainless steel. A specified opening gap is kept between the bars. The screen frame is fixed in the bar screen chamber at an angle of 60° to the horizontal, leaning away from the incoming side. Care is to be taken to see that there are no gaps left between the screen frame and the floor and the sides of the chamber.

The upper end of the screen must rest against an operating platform, on which the STP operator stands to rake the debris collected at the grill. The

platform itself must be provided with weep holes, so that the operator can leave the collected debris on the platform for some time to allow unbound water and moisture from the screened debris to drip back into the chamber. This not only reduces the weight and volume of trash to be finally disposed off, but also reduces the nuisance of odor coming from the putrefying matter.

## 1.5 Operation And Maintenance Considerations

- Check and clean the bar screen at frequent intervals
- Do not allow solids to overflow/ escape from the screen
- Ensure no large gaps are formed due to corrosion of the screen
- Replace corroded/ unserviceable bar screen immediately

## 1.6 Troubleshooting

Problem	Cause
Large articles pass through, and choke the pumps	Poor design / poor operation / screen damaged
Upstream water level is much higher than downstream level	Poor operation (inadequate cleaning)
Excessive collection of trash on screen	Poor operation
Excessive odor	Poor operation / trash disposal practices



# Oil And Grease/Grit Trap

## 2.1 Function

The grease and grit trap is placed at the discharge point of the canteen/ kitchen area itself to arrest solid and fatty matter at source. The wastewater output from this unit is taken to the **equalization tank**.

The solids and fats that are separated in this unit are disposed off along with other biodegradable waste, and can be used as feed for piggeries.

Separating solids (rice, vegetables, pulses) and grease from the wastewater at source ensures that

the contact time between solids and wastewater is kept to a minimum, so that the wastewater does not absorb additional organic pollutant loads (starch, carbohydrates, proteins) due to leaching of these substances from the solids. (Rather than building a larger STP to digest this extra organic matter, it is far more economical to prevent the organic matter from entering the STP.)

An Oil and grease/grit trap is generally not an essential unit in a typical residential complex. It is however a mandatory unit in commercial and Industrial units with a canteen on campus.

## 2.2 How It Works

A typical Oil and grease/grit trap is shown below (the front side is removed to show internal structure).

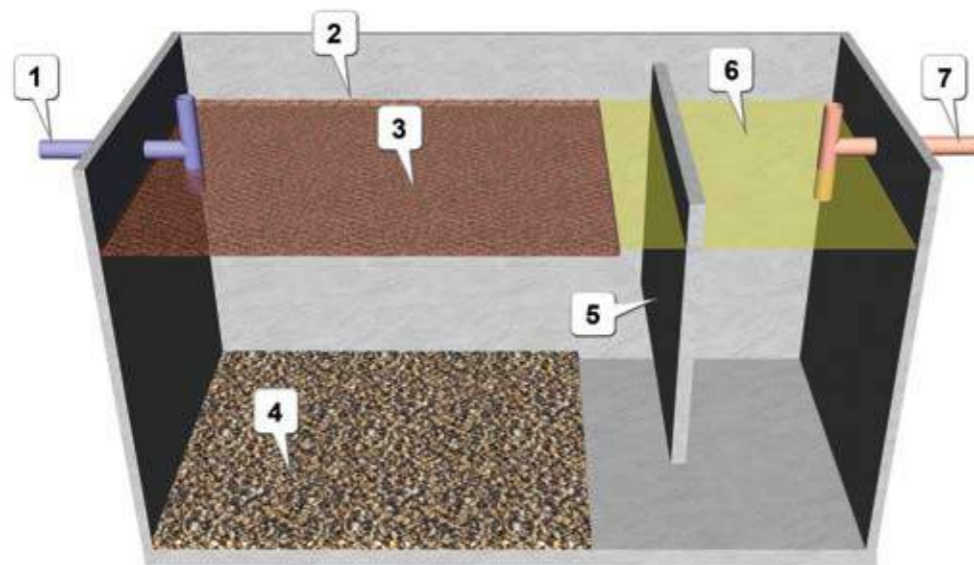

**Note:**

The tank is filled with wastewater, but it is not shown here so that the other items are visible.

SL	Remarks
1	The incoming liquid is released below surface through a <b>T-joint</b> so that the falling water does not disturb (break up) the floating film of fat and scum (3).

2	The tank is always filled till this <b>level</b> .
3	The <b>fat and scum</b> rise to the top and float on the liquid. This needs to be removed periodically, otherwise it will leach into the wastewater.

4	The heavier <b>grit and solids</b> sink to the bottom of the tank (most of it lies below the inlet pipe, but some of the grit may be moved toward the outlet side due to the strong flow of the wastewater).  This mass also needs to be removed from the tank periodically.
5	The <b>baffle plate</b> prevents the floating fat and scum (3) from drifting towards the outlet (7).
6	<b>Wastewater</b> reaching the outlet side is free of fat, scum, grit and solids
7	The <b>outlet</b> is through a T-joint pipe, similar to the inlet (1).  The upper part is capped off (opened only for maintenance).

## 2.3 Design Criteria

Typical design criteria used for the grease trap include:

1. Shallow trap (to allow quick rise of oils and fats to the surface)
2. The length of trap should be approximately 2 times its depth
3. Residence time in the trap is optimally 5-20 minutes at peak flow. (Increasing the time does not result in appreciable improvement)
4. Surface area of the trap in m<sup>2</sup> should be approximately 1.5 to 2 times the depth of trap in metres.

## 2.4 Construction And Engineering

The tank should have waterproof plastering inside and out.

The end of the incoming pipe is kept below the water level, so that the incoming water does not disturb (and break up) the upper floating layer of grease.

The trapped material (both floating film of grease/fat and the grit settled at bottom) must be collected frequently; otherwise the trap will fail to serve its fundamental purpose. Therefore the trap must be engineered to facilitate frequent removal of these two layers. For example, the covers must be made of lightweight materials for easy lifting.

Large traps may be provided with vent pipes to release gases.

## 2.5 Operation And Maintenance Considerations

- Check and clean trap at frequent intervals
- Remove both settled solids (at bottom) and the floating grease
- Do not allow solids to get washed out of the trap
- Do not allow oil and grease to escape the trap
- Redesign the trap if solids and grease escape on a regular basis, despite good cleaning practices

## 2.6 Troubleshooting

Problem	Cause
Oil and grease pass through the trap	Poor design/ poor operation
An excessive amount of solids passes through the trap	Poor design/ poor operation
Excessive odor	Poor operation/ waste disposal practices

# Equalization Tank

## 3.1 Function

The sewage from the **bar screen chamber** and **oil, grease and grit trap** comes to the **equalization tank**.

The equalization tank is the first collection tank in an STP.

Its main function is to act as buffer: To collect the incoming raw sewage that comes at widely

fluctuating rates, and pass it on to the rest of the STP at a steady (average) flow rate.

During the peak hours, sewage comes at a high rate. The equalization tank stores this sewage, and lets it out during the non-peak time when there is no/little incoming sewage.

Thanks to the constant outflow rate, it is easier to design the rest of the units of the STP.

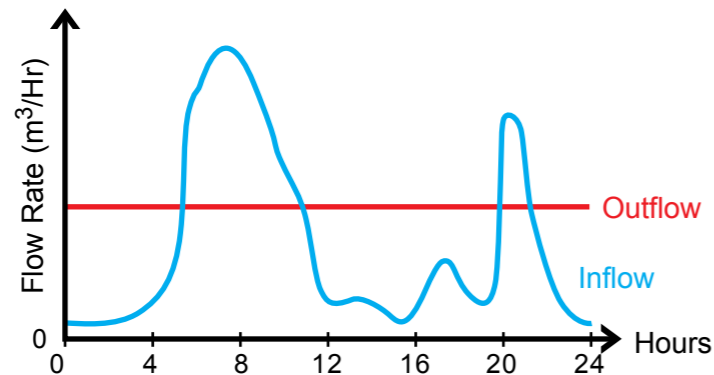

## 3.2 How It Works

A typical equalization tank is shown here.

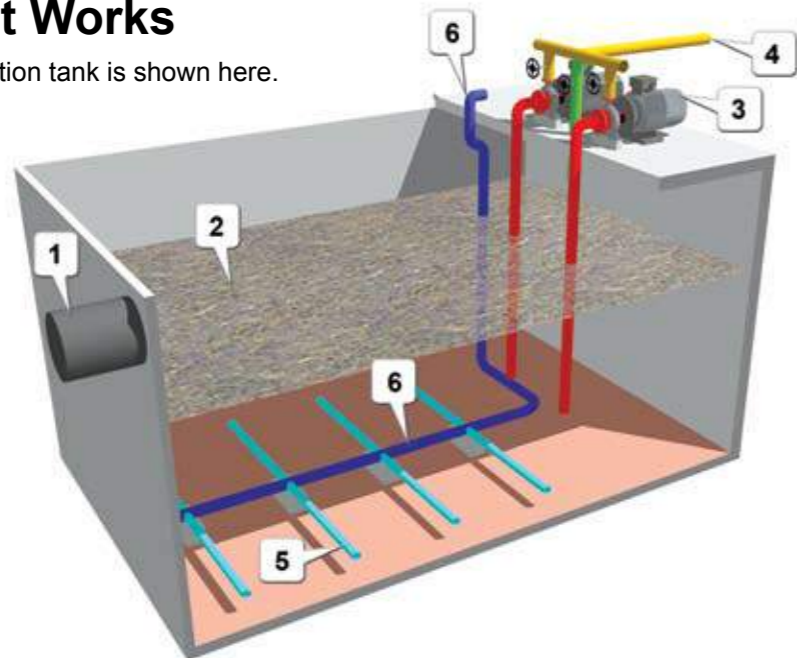

### Notes:

1. The figure uses color-coding only to distinguish the parts from each other: In real life the color-coding is not followed.
2. An air-compressor is required, but not shown because in most cases a single blower provides the compressed air needed at multiple places in the STP.
3. The figure shows only the surface of sewage (2), so that other items submerged in the sewage can be shown.

SL	Remarks
1	The <b>inlet pipe</b> carries filtered sewage from the Bar Screen Chamber.
2	The <b>sewage</b> is collected in the tank. The level fluctuates throughout the day, because while the incoming rate fluctuates widely, the outgoing rate is constant.  (The level shown in the figure is almost full. If there is a peak inflow now, the tank will overflow.)

3	The <b>raw sewage lift pumps</b> move the sewage to the aeration tank. (These pumps are explained in the next chapter.)
4	The <b>delivery pipe</b> takes the sewage to the aeration tank.
5	The <b>coarse bubble diffusers</b> are short length of tubes that have holes at regular spacing. They release large bubbles in the tank to lightly aerate the sewage, and also to agitate the mix continuously. The figure shows an array of eight diffusers, strapped to cement blocks so that the assembly remains firmly anchored in one place.  Diffusers can also be used in separate pairs or even individually.
6	Compressed air comes through this <b>air-supply pipeline</b> . This may be a rigid pipe or a flexible hose. The figure shows a single array of 8 diffusers. However, it is more convenient to use separate pairs of diffusers with their own air pipe (flexible hose).

## 3.3 Design Criteria

Since the diurnal variation in the quality of the sewage is not significant, the equalization tank is used only for buffering the daily fluctuations in the sewage flow quantity.

The equalization tank must be of sufficient capacity to hold the peak time inflow volumes.

Peak times and volumes are site-specific and variable:

- In the case of residential complexes, there is a distinct morning major peak (when all residents are using their kitchens, bathrooms and toilets), followed by a minor peak in the late evening hours. In a typical residential

complex, an equalization tank with a capacity to hold 4-6 hours of average hourly flow should be adequate (based on the diversity of the population in the complex).

- In addition, the sewage generation may be heavier during the weekends. In such cases, the sewage volume generated on a weekend should be taken as reference.
- In the case of a commercial or software complex, peak flows commonly occur during the lunch hour.
- In the case of manufacturing units, the shift timings is a major factor. Peaks occur at breakfast, lunch and dinner timings of the canteen.

A fairly scientific method of calculating the required capacity of the Equalization tank is by plotting a graph of the projected inflow and outflow over a 24-hour period, as shown below:

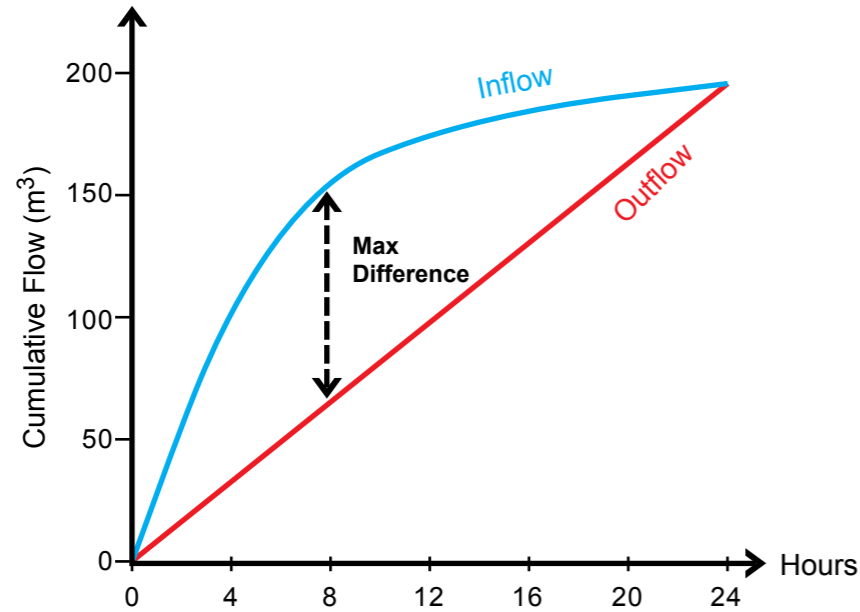

The equalization tank should be large enough to hold the maximum difference between the inflow and the outflow. In our example, the maximum difference is  $150-60=90 \text{ m}^3$ . Therefore, the equalization tank must be larger than  $90 \text{ m}^3$  (otherwise it will overflow).

### 3.4 Construction And Engineering

The incoming sewer line is usually gravity-fed, and is likely to be at considerable depth below the ground level. Therefore it is prudent not to make the tanks of STP too deep, otherwise it requires very deep excavations and expensive construction. It also makes the maintenance and cleaning processes very hazardous.

In it necessary to force compressed air in the sewage held in the tank. This is mandatory for two reasons:

- It keeps the raw sewage aerated, thereby avoiding septicity and suppressing odor-generation
- It keeps solids in suspension and prevents settling of solids in the tank, thereby reducing frequency of manual cleaning of the tank

The tank may be of any shape, provided it permits placement of air diffusers for full floor coverage and uniform mixing over the entire floor area.

The diffusers should be retrievable: Individual diffusers (or sets of diffusers) may be lifted out and cleaned for routine maintenance. This will reduce frequency of shut down of the Equalization tank for manual cleaning purposes.

If membrane diffusers are used, they will fail frequently, due to the repeated cycles of expansion and contraction caused by fluctuating water levels in the equalization tank. Therefore, only **coarse bubble diffusers** must be used in the equalization tank.

As a rule of thumb, the higher of the following two figures is taken as the air volume required per hour:

- 1.2-1.5 times the volume of the Equalization tank, or
- $2.5-3.0 \text{ m}^3/\text{m}^2$  of floor area.

The number and placement of diffusers must be adequate to dispense the calculated amount of air in the tank.

The capacity of the air blower must be adequate to deliver the required quantity of air to the equalization tank as well as all other aerated tanks it serves.

This tank is most prone to odor generation, since it contains raw (untreated) sewage. It may also build up gas, which can be explosive. Therefore it must have good ventilation.

### 3.5 Operation And Maintenance Considerations

- Keep air mixing on at all times
- Ensure that the air flow/ mixing is uniform over the entire floor of the tank. Adjust the placement of diffusers and the air-flow rate as needed.
- Keep the equalization tank nearly empty before the expected peak load hours (otherwise it will overflow)
- Check and clean clogged diffusers at regular intervals
- Manually evacuate settled muck/ sediments at least once in a year

### 3.6 Troubleshooting

Problem	Cause
Insufficient mixing/ aeration	Poor design, engineering
Excessive odor	Poor design, engineering
Insufficient capacity to handle peak flows	Poor design
Usable capacity reduced due to solids accumulation	Poor maintenance

# Raw Sewage Lift Pumps

## 4.1 Function

If we use gravity to move the sewage through the units of STP, the units would have to be placed progressively deeper below the ground level. To avoid deep excavations, a pumping stage is introduced to lift sewage to the next unit in the STP, which is the **aeration tank** in small STPs rated below 5000 m<sup>3</sup>/day.

This strategy yields a double benefit:

- All downstream units may be placed at a convenient level above ground, resulting in cost savings. At the same time, the maintenance of STP becomes easier.
- The pumping rate can be set at a calibrated uniform flow, so that downstream units are not affected by fluctuating flows.

## 4.2 How It Works

A typical pair of pumps (working and standby) is shown below:

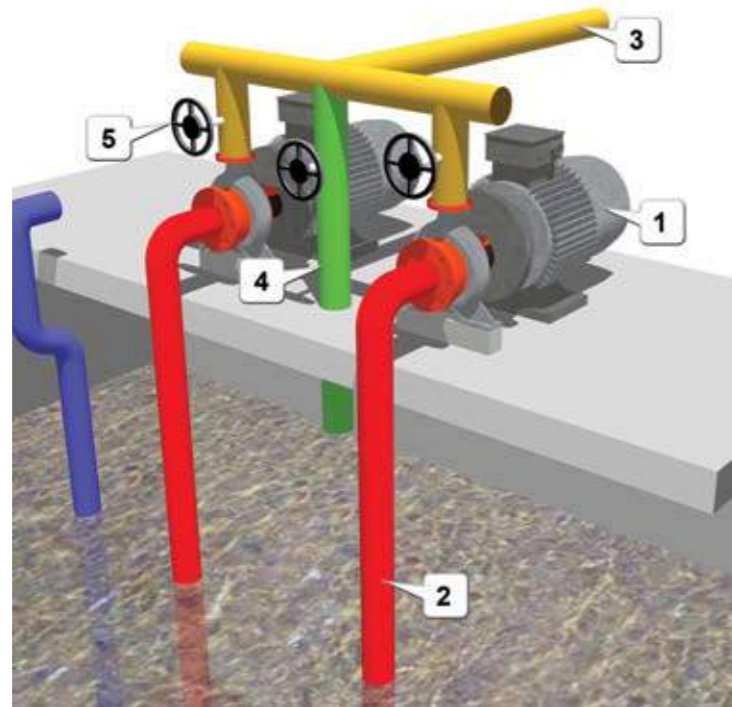

**Note:**

The example shows the pipelines in different colors only for illustration purposes. In actual practice, no such color-coding is followed.

SL	Remarks
1	There are two identical <b>pumps</b> . Controls ensure that only one pump can run at a time.  Each pump delivers sewage at a rate that is slightly higher than the actual flow rate of the STP.
2	Both pumps have independent <b>suction pipes</b> .  The inlet pipes extend almost to the bottom of the tank, and must not have foot-valves.
3	The delivery pipes from both pumps are combined in a π-shaped header.  A <b>delivery pipe</b> takes sewage from this header to the aeration tank.
4	The <b>bypass pipeline</b> returns the excess sewage back to the tank.
5	<b>Valves</b> fitted on all three pipelines serve different purposes: <ul style="list-style-type: none"> <li>The valve on the bypass line is adjusted to “waste” the excess capacity of the working pump. (The delivery pipeline (3) always carries sewage at the designed flow rate)</li> <li>The valve on the delivery pipe is closed off when the corresponding pump is removed for repairs. This prevents sewage delivered by the other pump from coming out.</li> </ul>

## 4.3 Design Criteria

The capacity of the raw sewage lift pump is selected based on daily average rated capacity of the STP, on the premise that the pumps shall be operated for 20 Hours in a day (For very large STPs, 22 hours of operation in a day may be considered).

STPs are usually designed with a duplicated pumping system: In place of using a single pump, two pumps are fixed in parallel, but only one pump is operated at a time. Such pumps can be operated round the clock (12 hours per pump).

The lifting capacity of the pumps (called ‘total head’ or ‘total lifting height’) may be selected based on the level difference between the sewage-delivery level at the aeration tank and the floor level of the equalization tank.

## 4.4 Construction And Engineering

Despite the presence of the bar screen(s) before the equalization tank, in real-life situations, we cannot rule out the presence of solids, polythene bags, plastic covers, cups etc. in the equalization tank.

These items pose a serious threat to the pumps.

Let us compare three different types of pumps for this job:

- Submersible pumps** with smaller flow passages in their impellers are not the correct application for this duty: They are prone to frequent failures (either the impeller gets damaged, or the pumps stall and then the winding burns).
- Comminutor pumps** with a cutter/shredder option solve the clogging issue by pulverizing the obstacles, but they end up mixing non-biodegradable material in the sewage in such a way that separating the material becomes impossible. This is a threat to the environment.
- Therefore, the correct choice would be horizontal, centrifugal, **non-clog, solids-handling (NC-SH)** pumps with open impellers.

There are other valid and practical reasons for this selection:

- The NC-SH pump is robust for this application, and failure rate/ frequency is very low.
- The NC-SH pumps are rated to handle solids up to even 20 mm size with an open impeller design, whereas submersible pump with closed impeller design comes with smaller openings.

- The NC-SH pumps are less expensive than submersible pumps, but work at a lower efficiency due to open impeller design.

In an STP, robust treatment performance is of prime importance and of higher priority than savings in energy at the cost of treatment efficiency.

- Repair/ servicing costs for NC-SH pumps are negligible compared to submersible pumps
- The NC-SH pumps may be serviced at the STP site itself within a few hours with readily available spares and consumables.

On the other hand, the submersible pumps have to be sent to their service center/ factory for any repairs, and the time required is typically 2 weeks.

- Once a submersible pump goes for repair, it never recovers 100% efficiency, and failures start occurring periodically (As per our experience, these pumps are for use and throw duty only)
- Guarantees/ warranties on repaired units are available, only if sent to the respective factories.
- The NC-SH pumps are equipped with a Non Return Flap valve in the body itself, which functions as a normal foot valve: hence priming of these pumps is not required at every start.

The raw sewage lift pump is a critical machinery, and so it must have a standby unit. The electrical control circuit must ensure that both pumps cannot run at the same time (otherwise they will generate excessive pressure and damage the plumbing. Also, a higher flow rate means partially treated sewage is passed out of STP.)

Separate suction piping for each of the two pumps is preferred, so that a clogged inlet pipe can be cleaned while the other pump is operating.

The delivery header of the two pumps must conform to good piping engineering practice with necessary fittings for isolating the pumps for maintenance, etc.

It is nearly impossible to get pumps that provide the exact combination of flow rate and head we need. Therefore, a bypass branch line (back to

the equalization tank) with a control valve must be provided, so that the sewage flow rate can be precisely set to the designed value.

- At the same time, provide for locking this valve, so that the STP operator cannot tamper with its settings to increase the flow rate.

Sufficient space must be allowed around the pump for movement of operators and technicians for routine operation and maintenance activities.

## 4.5 Operation And Maintenance Considerations

- Switch between the main and standby pump every 4 hours (approximately).
- Check oil in the pump every day; top up if necessary
- Check motor-to-pump alignment after every dismantling operation
- Check condition of coupling and replace damaged parts immediately
- Check for vibrations and tighten the anchor bolts and other fasteners
- Check condition of bearings, oil seals, mechanical seal and replace if necessary
- Completely drain out oil and replace afresh as per manufacturer's recommendation
- Always keep safety guard in its proper position
- Follow the LOTO safety principles while performing maintenance activities  
[http://en.wikipedia.org/wiki/Lock-out\\_tag-out](http://en.wikipedia.org/wiki/Lock-out_tag-out)
- Ensure discharge of raw sewage into the aeration tank is visible and can be monitored
- Maintain the flow rate at designed level (no tampering with the bypass valve)

## 4.6 Troubleshooting

Problem	Cause
Excessive noise	Poor engineering/ maintenance
Excessive vibration	Poor engineering/ maintenance
Overheating	Poor maintenance
Loss in efficiency of pumping	Poor maintenance

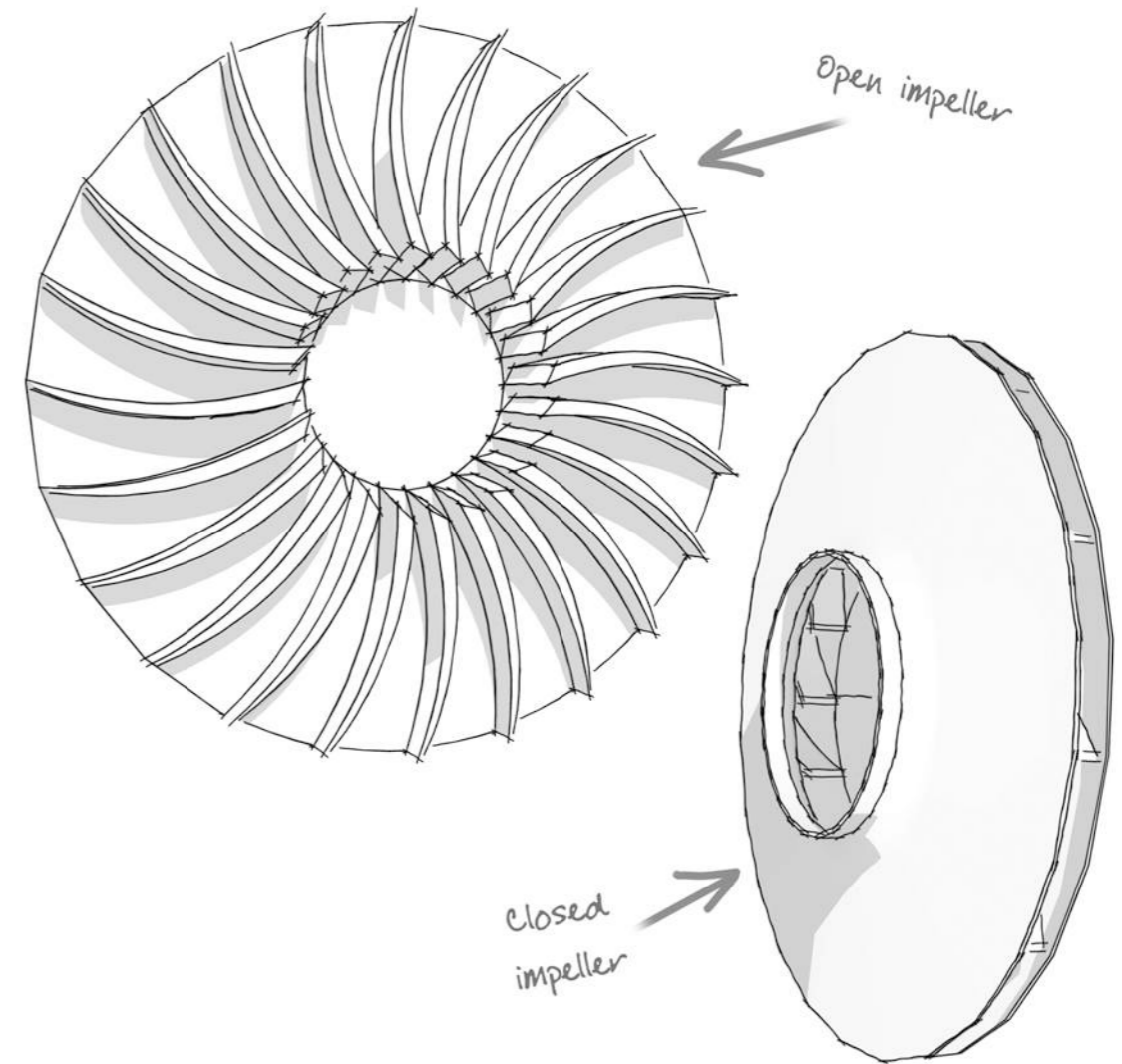

# Aeration Tank

## 5.1 Function

The Aeration tank (together with the settling tank/ clarifier that follows) is at the heart of the treatment system<sup>3</sup>.

The bulk of the treatment is provided here, employing microbes/bacteria for the process.

The main function of the Aeration tank is to

maintain a high population level of microbes. This mixture is called MLSS (Mixed Liquor Suspended Solids).

The mixed liquor is passed on to the clarifier tank, where the microbes are made to settle at the bottom. The settled microbes are recycled back to the aeration tank. Thus they are retained for a long period within the system (see **Appendix** - page 138).

## 5.2 How It Works

A typical Aeration tank is shown below.

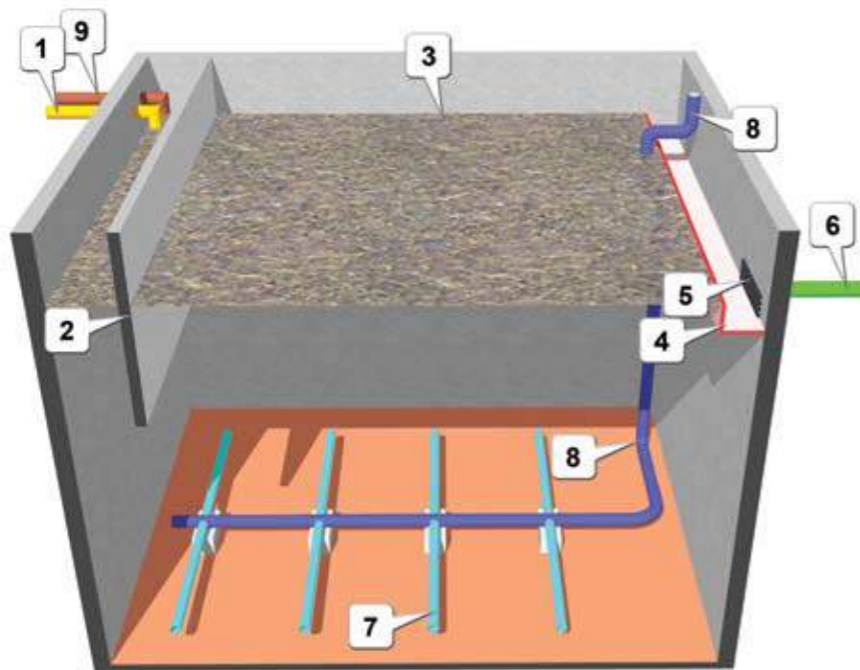

### Notes:

1. The figure shows only the surface of the sewage, so that items submerged in the sewage can be shown.
2. An air-compressor is required, but not shown because in most cases a single blower provides the compressed air needed at multiple places in the STP.

<sup>3</sup> Since both tanks work together, they cannot be explained in isolation.

SL	Remarks
1	The <b>inlet pipe</b> brings sewage from the raw sewage lift pump (sewage from the equalization tank). The pipe is bent downward, so that the sewage does not get propelled toward the outlet pipe (6).
2	The <b>baffle wall</b> does not let the incoming sewage and sludge go across the tank toward the outlet pipe (6). The wall forces the mix toward the bottom of the tank; thus ensuring maximum retention.
3	The tank is always filled till this <b>level</b> (which is set by the top of the launder (4)).  So the remaining height of the tank serves as freeboard (height margin to ensure that the tank does not overflow immediately under moderate emergencies.)
4	The <b>Outlet Launder</b> collects the sewage and delivers it to the outlet pipe (6).  Note that the outlet launder is located farthest from the inlet pipe (1) to minimize short circuiting of flow from the inlet to the outlet of the tank.
5	The <b>net</b> prevents entry of debris in the outlet pipe (6).  The operator should remove debris collected in the launder (4) periodically, otherwise eventually the mesh will be blocked with accumulated debris, resulting in a rise of water-level in the aeration tank. In the extreme case, this will cause overflow from the tank.
6	The <b>outlet pipe</b> takes the sewage to the settling tank/secondary clarifier.

<sup>4</sup> This approximation is only to give you a rough idea: The actual ratio depends on the design parameters.

7	The <b>fine bubble diffusers</b> are actually rigid pipes with long slots, which are then covered with tubular synthetic rubber membranes. The compressed air is released in the form of fine bubbles throughout the length of the diffusers, through minute holes punched in the rubber membrane. The figure shows an array of eight diffusers. The array is strapped to cement blocks (ballasts) to keep the entire assembly anchored to the bottom of the tank.
8	In the case of fixed diffusers, compressed air is supplied through a <b>header pipe</b> at the bottom of the tank, as shown.  Some designs use flexible air hose lines and pairs of diffusers to make them easily retrievable. In this case each pair of diffusers is also provided with a nylon rope to enable lifting out of the aeration tank for maintenance.
9	The <b>recirculated sludge pipeline</b> brings bacteria floc from the settling tank/secondary clarifier). It is always located very close to the inlet pipe (1) so that the raw sewage and bacteria get mixed thoroughly. (By design, both pipes deliver roughly the same volume per hour <sup>4</sup> .)

## 5.3 Design Criteria

When designing an STP, the following factors are already known:

- The quantity of sewage to be handled per day
- The pollutional potential of Indian domestic sewage, in terms of commonly understood parameters such as BOD (Biochemical Oxygen demand), COD (Chemical Oxygen Demand), TSS (Total Suspended Solids), O&G (Oil & Grease), etc.

Thus we know the amount of food available every day for the microbes to eat away.

The other factors are selected as follows:

Treatment efficiency	90 to 98 %, as defined by the Pollution Control Board.
Food/ Microorganisms ratio (F/M)	For STPs with extended aeration, required F/M is 0.10 to 0.12

This gives the required size (volume) of the aeration tank.

The next step is to calculate the amount of air to be pumped into the aeration tank, to keep the microbes alive and in continuous suspension (they must mix well with the food, and not settle at the bottom of the tank).

- In fact, the amount of air required for respiration of the microbes is always more than the amount of air required to keep the tank contents completely mixed. Therefore, we can simply calculate the air required for microbes; and it will serve the other purpose well.

The thumb rule is 50-60 m<sup>3</sup>/hr of air for every kg of BOD removed (i.e., the difference between BOD readings of the incoming sewage and treated sewage).

That concludes the design of the Aeration tank: the size (volume), concentration of microbes to be maintained, and the quantity of air to be supplied per hour.

## 5.4 Construction And Engineering

The Aeration tank is generally of waterproof RCC construction (as are most other tanks in the STP), designed as water-retaining structures as specified in relevant Indian codes.

The shape of the tank is not very critical, as long as adequate floor coverage and uniform mixing can be achieved by proper placement of diffusers on the tank floor.

5 The membranes are rated to operate within certain range of air flux rates. So power is saved by turning down (reducing) the air flow during certain times, such as night hours.

Operating platforms must be provided next to the tank, such that all the diffusers installed in the tank are easily accessible, and amenable to easy maintenance.

In theory, the desired volume can be achieved with multiple combinations of tank dimensions. However, in practice, the following factors limit the depth of the tank:

- The sewage depth may be between 2.5 - 4.0 m. The greater the water depth, the higher the efficiency of transfer of Oxygen to the tank contents. However, there is a penalty to be paid in the form of higher (and more difficult) maintenance, costs of a higher pressure air blower, higher air temperatures and related problems.
- Requirement for headroom above the tank, for operator comfort and to allow maintenance (e.g. to retrieve the heavy diffusers from bottom, you may need to fix a pulley system on the ceiling)

So the depth is fixed first. The length and width of the aeration tank may be computed to suit the diffuser membranes selected to provide the required quantity of air.

It is best to use the least possible number of membranes and therefore use the largest of the available sizes: 90 Dia x 1000 mm long. The lesser the number of membranes, the lesser is the maintenance, and the fewer the chances of malfunction.

Membrane diffusers are the preferred equipment for aeration in the aeration tank over other forms of aeration (low-speed surface aerators/ High-speed floating aerators/ submerged venturi aerators, etc.) for several reasons:

- Energy savings
- Less number of rotating machinery to be operated and maintained
- Turndown option<sup>5</sup>
- Standby facility

- Gentle aeration (less breakage of the biomass floc)
- Performance unaffected by foaming in tank
- Substantial reduction in aerosol formation (Safe working conditions)
- Mixing in depth
- Design can take into account the following factors: pressure, temperature, altitude, viscosity, fouling, aging, etc.
- Non-interruptive maintenance/ replacement is possible

The diffusers must be retrievable, for regular cleaning and maintenance without having to empty the aeration tank. (Regular cleaning extends the life of the diffusers).

It is necessary to ensure that the incoming sewage does not go to exit directly. To minimize this "short circuiting", raw sewage lift pumps must deliver the sewage at one end of the tank, and the outflow must be as far away from this point.

For the same reason, the sludge recirculation pipe (from the settling tank) must deliver sludge in the vicinity of the sewage inlet, to maximize the contact time of microorganisms with raw sewage.

The outlet end may be provided with a launder at the desired water level in the tank (which in fact fixes the water level in the tank). It is also useful to fix a coarse mesh screen in the launder to trap any stray trash from entering the secondary settler tank.

Sufficient freeboard must be provided in the tank, so that even in the event of emergencies (such as blockage of pipe between aeration tank and settling tank, excessive foaming etc.) overflow from the aeration tank can be avoided for some time. Note that the freeboard only gives the STP operator some additional time to react to an emergency, but it would not be able to prevent an overflow.

All things considered, chances of poor engineering in the aeration tank affecting STP performance are far less compared to the settling tank (secondary clarifier-- the next tank in the chain).

The microbes produce a large amount of Carbon Dioxide, which must be handled by the exhaust and ventilation system.

## 5.5 Operation And Maintenance Considerations

Operation considerations include maintaining the correct design level of MLSS (biomass concentration) in the aeration tank. Problems arise both in the case of excess or shortage of biomass, causing an imbalance, leading to failure of the process. The next chapter shows how to maintain the correct design level of MLSS in the aeration tank.

See appendix (page 139) to understand how MLSS ratio is measured and controlled.

Visual observation will indicate if there is uniform aeration and mixing over the entire area of the tank. Local violent boiling/ bubbling is indicative of ruptured membranes. Dead zones on the sewage surface indicate that membranes are blocked from the air side or the liquid side. Both conditions call for immediate attention, by cleaning or replacing the membranes.

Cleaning of membranes is generally carried out by lifting out the defective units and scouring out the adhering materials by high-pressure hosing. Scrubbing with mild acid solution may also be resorted to in case of stubborn encrustation.

Foaming in the aeration tank may be caused by excessive inflow of detergent-like substances: In a great majority of cases, the cause may be traced to an imbalance in the aeration tank recipe (Food: Microorganisms: Air: Nutrients), and corrective measures may be taken as indicated.

## 5.6 Troubleshooting

Problem	Cause
Inadequate mixing/ aeration	Poor design/ engineering/ maintenance
Violent boiling in tank	Ruptured membranes/ damaged pipeline
Black coloration (medium to dark brown color indicates good health)	Poor design/ engineering
Foaming Note: Foaming during initial start-up of STP is normal, due to the acclimatization period of the bacteria in the growth phase.	Poor design/ engineering/ operation
Paucity of bacteria <ul style="list-style-type: none"> <li>• Very light colored liquid in Aeration Tank</li> <li>• MLSS below acceptable limits</li> </ul>	Poor design/ engineering/ operation

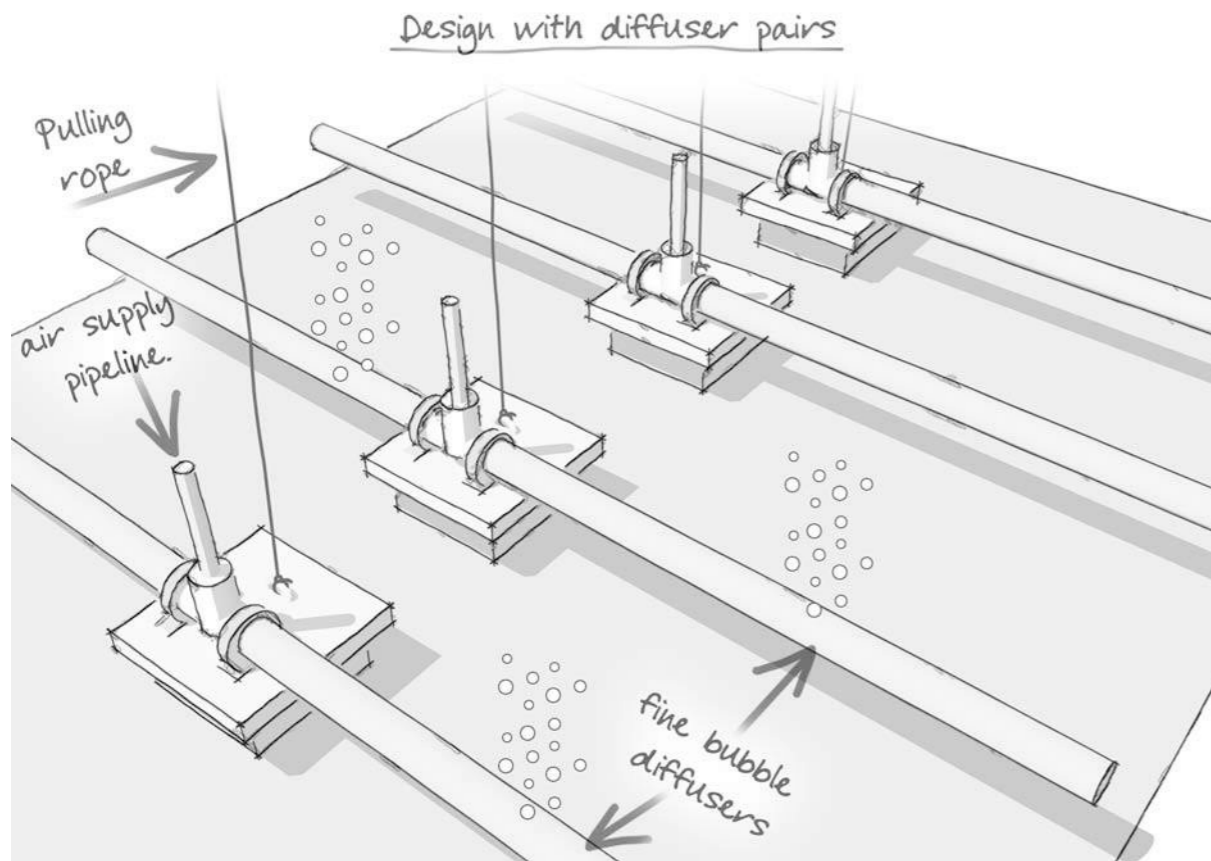



# Secondary Clarifier/ Settling Tank

## 6.1 Function

The purpose and function of the secondary clarifier is threefold:

- Allow settling of biomass solids in the Mixed Liquor (biomass slurry) coming out of the aeration tank, to the bottom of the clarifier
- To thicken the settled biomass, in order to produce a thick underflow
- To produce clear supernatant water, in the overflow from the clarifier

The clarifier tank is only a passive device: All the above actions occur due to gravity.

The thick biomass is recirculated back to the aeration tank.

## 6.2 How It Works

The clarifier tanks can be classified in two groups: mechanized and unmechanized.

- In an unmechanized clarifier, the bottom of the tank is shaped like a funnel, with a steep slope. The sludge slowly settles towards bottom, and slides down the slope to collect at the lowest point of the funnel-shaped bottom.
- In a mechanical clarifier, the bottom of the tank has only a gentle slope toward the center. The sludge settles uniformly across the floor of the tank. A set of slowly rotating rubber blades sweep the sludge into a hopper at the center of the tank<sup>6</sup>.

There are three popular design variations in the unmechanized clarifier tank.

They differ in the manner in which the sludge is collected and returned to the Aeration tank.

Air-lift pump	Sludge is collected with an air-lift pump. By varying the air pressure, the flow rate of the sludge can be adjusted. This version is most prevalent.
Electric pump-Direct suction	Sludge is collected with an electric pump. Since the flow rate of this pump cannot be varied, the pump is turned off periodically to arrive at a lower net flow rate. (For example, it is kept off for 10 minutes every hour.)
Electric pump and buffer sump	Sludge is allowed to flow in a buffer sump (using gravity). From here, sludge is pumped back to aeration tank using a pump. The net flow rate is adjusted using a bypass pipeline with a valve (exactly like the raw sewage lift pumps).

The unmechanized and mechanical varieties of clarifiers are explained next.

### 6.2.1 Settling tank with air-lift pump

A typical settling tank with air-lift pump is shown on the next page.. (The front side is removed to show internal parts.)

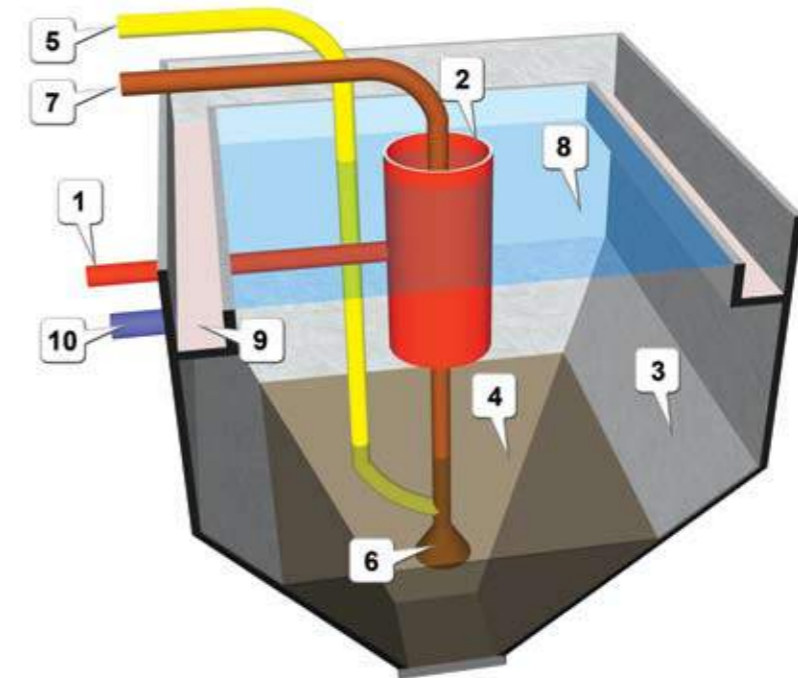

SL	Remarks
1	The <b>sewage inlet pipe</b> brings sewage from the aeration tank.
2	The <b>center-feed well</b> (also called "inflow well") takes this incoming sewage and gently releases it in the settling tank, without causing any disturbance or turbulence. Note that the well is always filled with water because of its position. So the incoming sewage does not drop from a height and disturb the sludge that is already settling toward the bottom of the tank.  Also note that the top of the well is positioned above the water surface, so that the incoming water cannot find a path of least resistance, straightway rise to the top and exit to the launder. (If that is allowed to happen, then the solids will never be able to settle.)

3	The sludge is only slightly heavier than water; so it takes time to sink. It slides down the <b>steeply sloped walls of the tank</b> toward the center of the bottom.
4	The <b>bacterial flocs</b> <sup>7</sup> collect here in high concentration <sup>8</sup> . Even when the flocs settle at bottom, they actually remain suspended in water, rather than forming a solid sediment.  <b>Note:</b> This figure shows it as semitransparent only to show the suction pump mechanism. In real life, the mix would be a dense opaque mass.  The upper part of the tank, till the surface, holds clear water (the figure shows only its surface <b>8</b> ).

7 Each floc is loosely aggregated mass of bacteria. It is a brownish tiny ball of 2-3 mm dia, with a soft, spongy and slimy texture.

8 This simplified diagram shows a separate layer of flocs at bottom. In reality, at any given moment, the newly arriving flocs are gradually sinking, and clear water is rising upward. This creates a gradual increase of floc-density toward the bottom of the tank, but there are no distinct layers.

6 This is just like how the windshield wipers in your car sweep water.

	The <b>compressed air pipe (5)</b> feeds compressed air to the airlift pump. As this air is released near the bottom, it expands suddenly in bubble form and rises to the top through the <b>delivery pipe (7)</b> . The Venturi effect at the joint of <b>5</b> and <b>7</b> creates a partial vacuum, and sucks in the bacterial flocs through the <b>inverted funnel (6)</b> . The compressed air propels this mass up through the <b>delivery pipe (7)</b> .
<b>8</b>	The <b>clear water</b> rises to the top of the tank.

<b>9</b>	Typically the tank has <b>launders</b> on all four sides. (The launder on the front is not shown, so that the other parts can be shown clearly.)  If the water overflowed over the weir at fast velocity, it will pull up the solids from the bottom of the tank. This is prevented by providing weir of sufficient length.  In small plants, launder on a single side is adequate.
<b>10</b>	The <b>clarified water pipe</b> takes the decanted water to the clarified water sump.

## 6.2.2 Settling tank with direct-suction electric pump

A typical settling tank with a direct-suction electric pump is shown below. (The front side is removed to show its internal parts.)

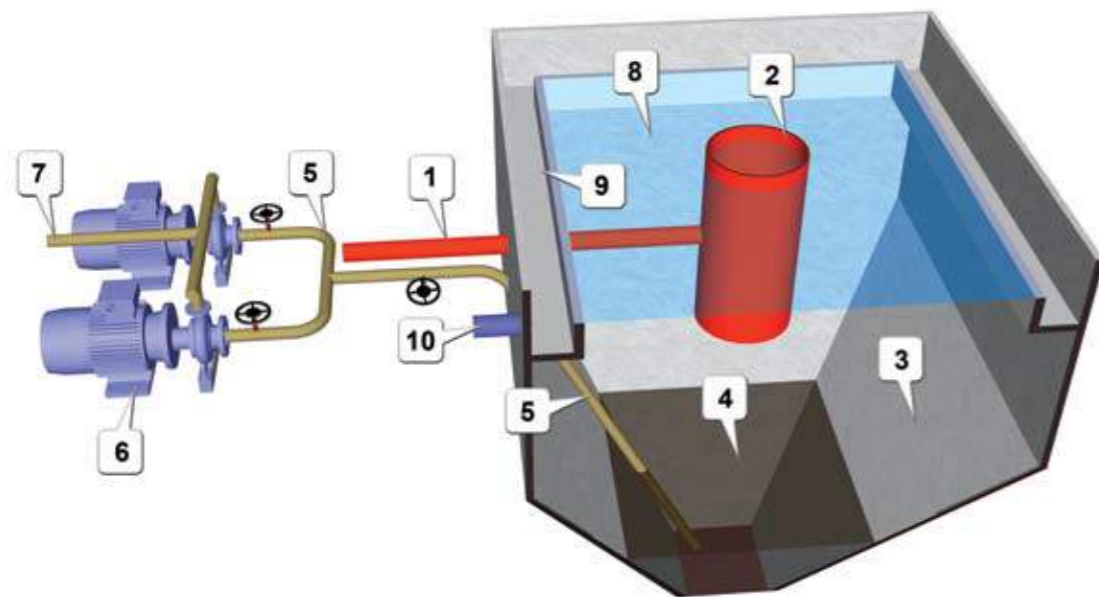

SL	Remarks
<b>1</b>	The <b>sewage inlet pipe</b> brings sewage from the aeration tank.
<b>2</b>	The <b>center-feed well</b> (also known as “ <b>influent well</b> ”) takes this incoming sewage and gently releases it in the settling tank, without causing any disturbance or turbulence. Note that the well is always filled with water because of its position. So the incoming sewage does not drop from a height and disturb the sludge that is already settling toward the bottom of the tank.  Also note that the top of the well is positioned above the water surface, so that the incoming water cannot find a path of least resistance, straightway rise to the top and exit to the launder. (If that is allowed to happen, then the solids will never be able to settle.)
<b>3</b>	The sludge is only slightly heavier than water; so it takes time to sink. It slides down the <b>steeply sloped walls of the tank</b> toward the center of the bottom.
<b>4</b>	The <b>bacterial flocs</b> <sup>9</sup> collect here in high concentration <sup>10</sup> . Even when the flocs settle at bottom, they actually remain suspended in water, rather than forming a solid sediment.  <b>Note:</b> This figure shows it as semitransparent only to show the suction pump mechanism. In real life, the mix would be a dense opaque mass.  The upper part of the tank, till the surface, holds clear water (the figure shows only its surface <b>(8)</b> ).

<b>5</b>	The <b>sludge delivery pipe</b> delivers <sup>11</sup> the slurry (a mix of flocs and water) to the pumps <b>(6)</b> . The pipe is split between the two pumps (they do not have separate inlet pipes).  The valve on the main pipe is used to close it during maintenance. The valves near the pumps regulate the flow, and also close the pipe when the corresponding pump is removed for repairs.
<b>6</b>	There are two identical <b>pumps</b> . Controls ensure that only one pump can run at a time.  Each pump delivers sludge at a rate that is slightly higher than the required flow rate. Since the flow rate of these pumps is fixed, they need to be turned off periodically to bring down the net flow rate to achieve the desired MLSS ratio.  This is a critical operation, because if flocs remain in the settling tank for more than 30 minutes, the microorganisms die due to lack of oxygen. Therefore the on/off cycles have to be small.  Since this is a round-the-clock operation, and a critical task, this is done using a timer circuit that turns the pump on/off automatically. The operator has to monitor the MLSS ratio, and keep adjusting the timer’s duty cycle (the on/off periods) as required.
<b>7</b>	The π-shaped <b>header assembly</b> joins the outlet pipes of both pumps, and delivers the sludge to the aeration tank.
<b>8</b>	The <b>clear water</b> rises to the top of the tank.

9 Each floc is loosely aggregated mass of bacteria. It is a brownish tiny ball of 2-3 mm dia, with a soft, spongy and slimy texture.

10 This simplified diagram shows a separate layer of flocs at bottom. In reality, at any given moment, the newly arriving flocs are gradually sinking, and clear water is rising upward. This creates a gradual increase of floc-density toward the bottom of the tank, but there are no distinct layers.

11 Because of the water column above, the slurry is delivered with pressure. Thus the pumps do not need to apply suction: They work only to lift the slurry to the top of the aeration tank.

<b>9</b>	Typically the tank has <b>launders</b> on all four sides. (The launder on the front side is not shown, so that the other parts can be shown clearly.)  If the water overflowed over the weir at fast velocity, it will pull up the solids from the bottom of the tank. This is prevented by providing weir of sufficient length.  In small plants, launder on a single side is adequate.
<b>10</b>	The <b>clarified water pipe</b> takes the decanted water to the clarified water sump.

Because of the requirement to switch the pump on/off round the clock (and the consequences of an operator mistake), this method is not recommended.

The next variant overcomes the design limitations mentioned above.

### 6.2.3 Settling tank with buffer sump

This design overcomes the critical deficiencies in the **direct-suction electric pump** version.

The settling tank is built just like the direct-suction electric pump version, but two critical external components are added: An intermediate tank with aeration, and a bypass pipeline. These additional components keep the bacteria flocs alive, and also allow the operator to adjust the sludge flow rate to get the desired MLSS ratio.

A typical settling tank with buffer sump is shown below. (The front side is removed to show its internal parts.)

SL	Remarks
<b>1</b>	The <b>sewage inlet pipe</b> brings sewage from the aeration tank.

<b>2</b>	The <b>center-feed well</b> (also known as <b>"influent well"</b> ) takes this incoming sewage and gently releases it in the settling tank, without causing any disturbance or turbulence. Note that the well is always filled with water because of its position. So the incoming sewage does not drop from a height and disturb the sludge that is already settling toward the bottom of the tank.  Also note that the top of the well is positioned above the water surface, so that the incoming water cannot find a path of least resistance, straightway rise to the top and exit to the launder. (If that is allowed to happen, then the solids will never be able to settle.)
<b>3</b>	The sludge is only slightly heavier than water; so it takes time to sink. It slides down the <b>steeply sloped walls of the tank</b> toward the center of the bottom.
<b>4</b>	The <b>bacterial flocs</b> <sup>12</sup> collect here in high concentration <sup>13</sup> . Even when the flocs settle at bottom, they actually remain suspended in water, rather than forming a solid sediment.  <b>Note:</b> This figure shows it as semitransparent only to show the suction pump mechanism. In real life, the mix would be a dense opaque mass.  The upper part of the tank, till the surface, holds clear water (the figure shows only its surface <b>8</b> ).

<b>5</b>	The <b>sludge delivery pipe</b> delivers <sup>14</sup> the slurry (a mix of flocs and water) to the <b>buffer sump (6)</b> .  Note that the pipe is located below the water surface, therefore the slurry is delivered with pressure.  The valve on the pipe is used to regulate the slurry flow rate and also to close the pipe during maintenance.
	The slurry remains in the sump ( <b>6</b> ) only for a short time.  The <b>compressed air pipeline (7)</b> provides air to the <b>coarse air bubble diffusers (8)</b> , which release large bubbles in the slurry. This not only provides oxygen to the bacteria, but also continuously agitates the slurry to prevent settling of the flocs to the bottom of the sump <sup>15</sup> .
<b>9</b>	There are two identical <b>pumps</b> which pass the slurry to the Aeration tank.  Controls ensure that only one pump can run at a time.  Each pump delivers sludge at a rate that is slightly higher than the required flow rate. The extra flow is diverted back to the sump through the <b>bypass pipeline (10)</b> . The returning slurry is released at a height, thus agitating the contents of the sump.  The valve on the bypass line is adjusted to achieve the desired net flow rate.

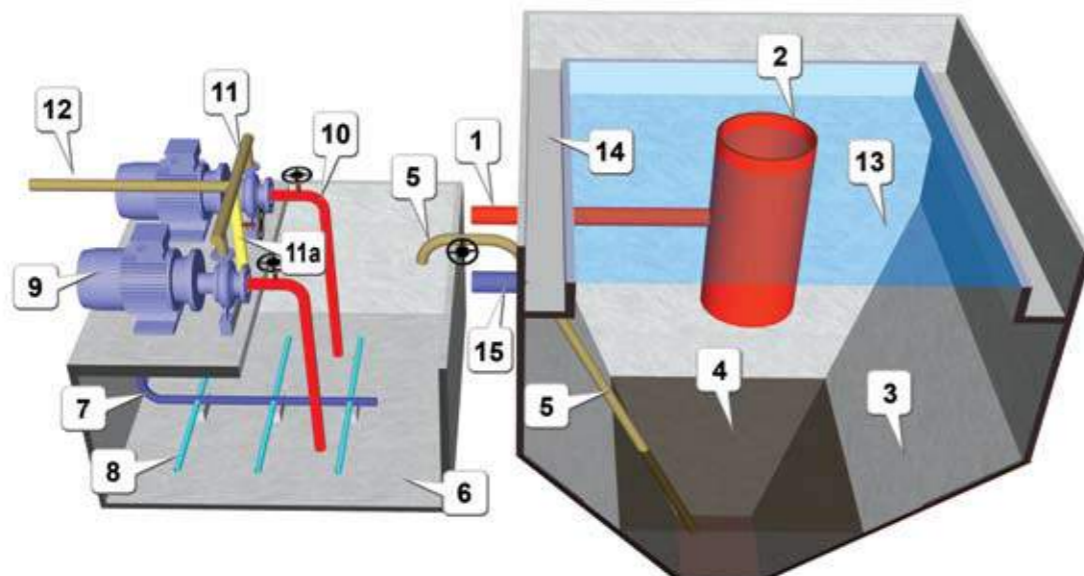

- 12 Each floc is loosely aggregated mass of bacteria. It is a brownish tiny ball of 2-3 mm dia, with a soft, spongy and slimy texture.
- 13 This simplified diagram shows a separate layer of flocs at bottom. In reality, at any given moment, the newly arriving flocs are gradually sinking, and clear water is rising upward. This creates a gradual increase of floc-density toward the bottom of the tank, but there are no distinct layers.
- 14 Because of the water column above, the slurry is delivered with pressure. Thus the pumps do not need to apply suction: They work only to lift the slurry to the top of the aeration tank.
- 15 If any flocs settle to bottom, they will not be recirculated to the aeration tank, and they will die because of lack of food. Just oxygen is not sufficient to keep them alive.

<b>11</b>	The π-shaped <b>header assembly</b> joins the outlet pipes of both pumps, and delivers the sludge to the aeration tank via the <b>delivery pipe (12)</b> .
<b>13</b>	The <b>clear water</b> rises to the top of the tank.  (This figure shows only the surface, but the upper part of the tank is filled with clear water).

<b>14</b>	Typically the tank has <b>launders</b> on all four sides. (The launder on the front side is not shown, so that the other parts can be shown clearly.)  If the water overflowed over the weir at fast velocity, it will pull up the solids from the bottom of the tank. This is prevented by providing weir of sufficient length.  In small plants, launder on a single side is adequate.
<b>15</b>	<b>The clarified water pipe</b> takes the decanted water to the clarified water sump

### 6.2.4 Mechanized Clarifier Tank

The three types of clarifier tanks described so far were not mechanized: In those tanks, the sludge settles and moves to the deepest part of the tank due to gravity, from where a pump takes it to the aeration tank.

In a mechanized clarifier tank, the sludge settles at the bottom over a wide area, and a few rubber wiper blades (called “squeegees”) sweep it to a pit at the center of the tank, from where a pump takes it to the aeration tank.

This design is used for large STPs only.

A typical tank is shown below.

As shown, the tank is cylindrical, with bottom that slopes toward the center, with very little slope.

The figure does not show the clarified water and sludge, so that the submerged parts can be shown clearly,

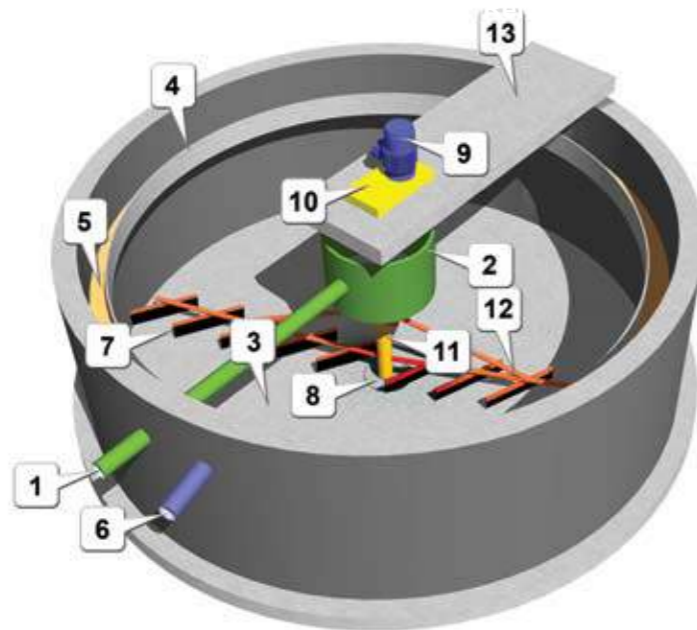

**The sewage inlet pipe (1)** brings sewage from the aeration tank.

The **center-feed well (also known as “influent well”)** (2) takes this incoming sewage and gently releases it in the settling tank, without causing any disturbance or turbulence. Note that the well is always filled with water because of its position. So the incoming sewage does not drop from a height and disturb the sludge that is already settling toward the bottom of the tank.

Also note that the top of the well is positioned above the water surface, so that the incoming water cannot find a path of least resistance, straightway rise to the top and exit to the launder. (If that is allowed to happen, then no settling of solids will occur.)

The sludge is only slightly heavier than water; so it takes time to sink.

The **bacterial flocs**<sup>16</sup> collect at the bottom in high concentration<sup>17</sup>. Even when the flocs settle at bottom, they actually remain suspended in water, rather than forming a solid sediment.

Since the **bottom (3)** has very little slope, the flocs do not move from their settling spot.

The clear water rises to the top. Most of the tank is filled with clear water (not shown here), As we go down, we find the sludge in progressively higher concentration.

The tank has a **launder (5)** around its periphery.

The clear water flows over its top edge (4) (called “weir”) into the launder, and is collected by the **outlet pipe (6)** and taken to the filter units (pressure sand filter and activated carbon filter).

Note that the position of the launder determines the depth of water in the tank: Under normal running condition, the water level never rises beyond the weir. It rises only when the outlet pipe is blocked for some reason.

So the remaining height of the tank above the weir serves as freeboard (height margin to ensure that the tank does not overflow immediately under moderate emergencies.)

The bacterial flocs settled at the bottom have to be quickly collected and sent back to aeration tank, otherwise they would die because of lack of oxygen and food.

This is done with a set of rubber blades (called “squeegees”) (7): The squeegees sweep the floor in circular movement, and propel the sludge toward a **collection-pit (8)** at the center of the tank. From here, a pump takes the sludge to aeration tank.

The squeegees work just like how a windshield wiper works in your car.

Note how each squeegee is set at an angle. When a squeegee sweeps through the layer of accumulated sludge, the sludge slides towards its trailing edge. The squeegee leaves a continuous ridge of sludge at the trailing edge. (The five squeegees on each arm leave five ridges of sludge behind.)

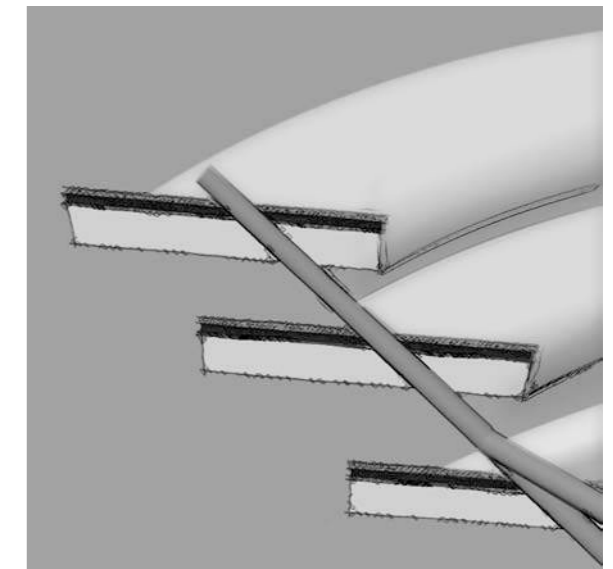

16 Each floc is loosely aggregated mass of bacteria. It is a brownish tiny ball of 2-3 mm dia, with a soft, spongy and slimy texture.

17 At any given moment, the newly arriving flocs are gradually sinking, and clear water is rising upward. This creates a gradual increase of floc-density toward the bottom of the tank, but there are no distinct layers.

Each ridge is then collected by the next squeegee in the opposite arm of the rake (after the rake turns by half a turn), and again pushed toward the center.

Thus each pass of the squeegees moves the sludge toward the center by one blade length. The last squeegees (nearest the center) drop the sludge into the collection pit.

Thus, if each arm has five squeegees, the sludge will take up to five rotations of the rake to reach the pit.

Also note that the squeegees are arranged to cover the entire floor of the tank; especially the outer periphery. This is a critical requirement: It ensures that the bacterial flocs do not remain in the Clarifier tank for extended period and die.

The circular motion of the squeegees is achieved through the following mechanism:

A **motor (9)** drives a **speed-reduction gear box (10)**, The gear box drives a **shaft (11)**. The shaft is attached to the **frame (12)** that carries all the **squeegees (7)**.

Thus when the motor rotates at its normal speed, the frame rotates at a very slow speed in the tank. This slow speed ensures that the sludge settled at the bottom of the tank is not stirred up.

The **platform (13)** (also called “**bridge**”, because it spans across the tank in most designs)<sup>18</sup> allows mounting of the driver motor, and also allows the STP operator to observe the tank from above.

It always has safety hand-rails (not shown in the figure to reduce complexity.)

Some critical details of the sludge-collection pit are shown below:

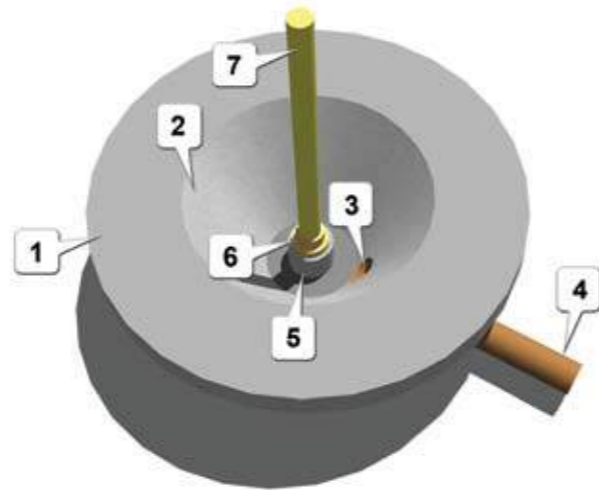

The figure shows only some part of the **tank floor (1)**. A bucket-shaped **sludge-collection pit (2)** collects the sludge that is swept by the squeegees.

The collected sludge is pumped out through the **outlet port (3)** and **outlet pipe (4)**

In the center of the pit, an **RCC pillar (5)** is provided. A **bush housing (6)** is mounted on this pillar.

The housing contains a bush, which provides a frictionless support to the **rotating rake (7)**. This ensures that the rotating rake remains steadily centered in the tank; and more importantly, the squeegees remain in contact with the floor as they rotate.

If a bush is not provided, the rake would be dangling from the platform. As it rotates in the thick slurry, it meets uneven resistance and currents; and starts swinging.

As a result, the squeegees cannot remain in touch with the floor, and their sweeping action is not uniform. That leaves a lot of sludge unswept on the floor. A second major problem is the rubber

squeegees strike the floor violently, and get damaged. Such torn squeegees cannot sweep the sludge properly. Again, this leaves a lot of sludge unswept on the floor. Bacteria that cannot be collected within one hour from the clarifier tank die, and turn septic.

Thus the bottom bush plays a vital role.

In some designs, a **sludge-concentrator** (not shown here) is fitted on the central shaft (7)

The concentrator is like a large screw. It rotates with the rake, and pushes/squeezes the flocs down the pit. At the bottom of the pit, the floc concentration is the highest. This increases the density of the slurry that is returned to the aeration tank

## 6.3 Design Criteria

The fundamental design criterion for clarification of the mixed liquor coming into the clarifier is the cross-sectional area of the clarifier. In the strictest theoretical sense, the depth of the clarifier has no role to play in the “clarification” function: Increasing depth of the clarifier only helps in the “thickening” function.

Clarifier cross-sectional area is typically computed at between 12 – 18 m<sup>3</sup>/hr/m<sup>2</sup> of throughput flow of sewage, depending on various other factors. For small domestic STPs, a figure of 16 may be taken as the golden mean.

It is customary to specify depth of clarifier between 2.5 to 3.0 m.

In order to restrict localized high upflow velocities, clarifiers have to be provided with sufficient length of “weir” over which overflow occurs. In small clarifiers, the “Weir Overflow Rate” does not assume critical significance, and in a square tank, a weir on a single side of the tank will be sufficient. Circular clarifiers in most cases are built with an all-round weir, which again is adequate.

Another design consideration is the “Solids Loading Rate” in the clarifier - i.e. kg solids/m<sup>2</sup>/Hr. In typical domestic STPs, this parameter is not of great significance.

## 6.4 Construction And Engineering

Proper construction and engineering of a clarifier/ settling tank is of utmost importance, and several factors need to be considered and executed with great precision. Any deficiency in even one of these aspects can make or mar an STP. Some of the more critical factors are listed below:

- Steep slope in the hopper-bottom settling tank (> 45°)
- Weir at uniform level
- Influent feed well to kill turbulence of incoming mixed liquor from the aeration tank
- Radial entry of mixed liquor into the feed well
- Minimum difference in water level in aeration tank and clarifier (not more than 0.2 m)
- Minimum footprint of the central sludge-collection hopper
- If a square tank is fitted with a mechanical rake, its corners (which are not swept by the blades) must have steep slope.
- Uniform slope in floor, without major undulations
- Rubber squeegees of the mechanical rake to sweep the floor
- Number, angle and length of rake blades on the rake arm
- Speed of the rake arm
- Bottom “steady bush” for the vertical shaft of rake arm in large clarifiers to prevent oscillation of the rake arms
- If the sludge-withdrawal pipe is buried beneath the floor in a mechanical clarifier, it shall be minimum 4” diameter.

<sup>18</sup> This figure shows only half of the bridge, so that the items located under it can be shown clearly.

## 6.5 Operation And Maintenance Considerations

If properly designed, engineered and constructed, clarifiers call for very little attention in terms of operation and maintenance. Indeed, the unmechanized (hopper-bottom) settling tanks may be said to be zero- maintenance units. Some parts of the mechanical rake (such as the motor, gearbox etc.) call for only routine maintenance. The sacrificial rubber squeegees sweeping the floor of the clarifier need to be checked and replaced, possibly once in two years.

## 6.6 Troubleshooting

Problem	Cause
Solids are carried over with decanted water	Poor design/ engineering/ operation/ maintenance
Mushroom cloud of solids	Poor engineering/ maintenance
Poor settlement of solids	Poor design/ engineering
Thin slurry in underflow	Poor design/ engineering
Excessive turbulence in clarifier	Poor engineering
Rotational flow of solids in upper layers <sup>19</sup>	Poor engineering

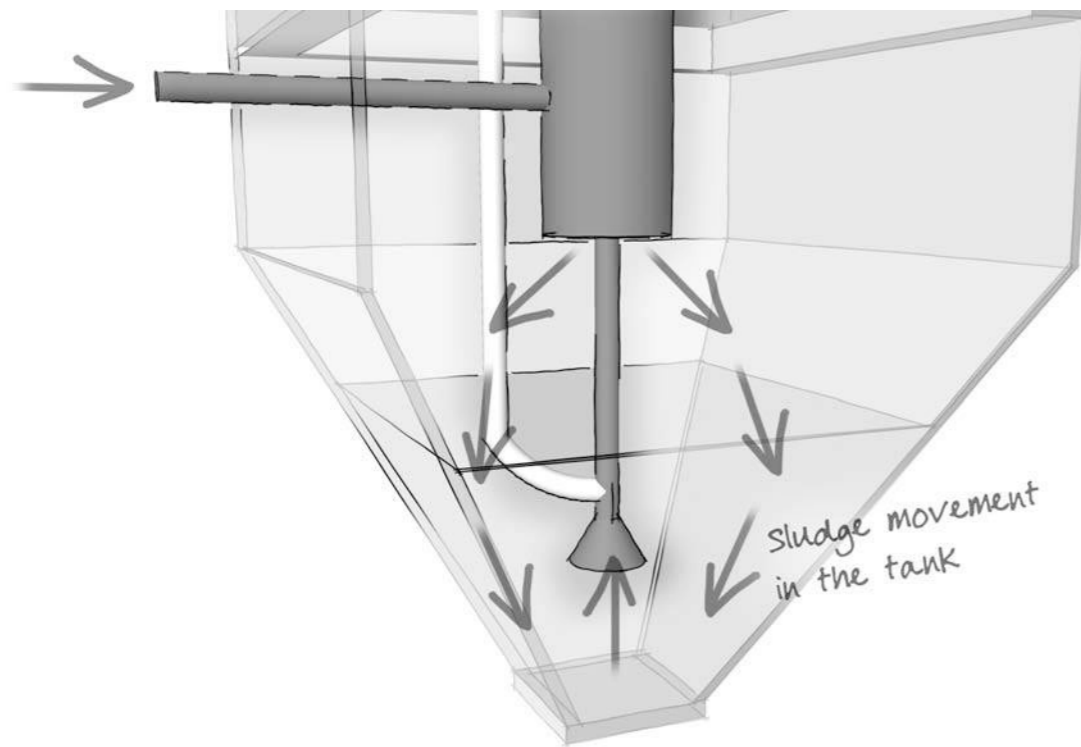

<sup>19</sup> In fact, any movement of water in the clarifier should not be noticeable at all, except near the overflow weirs, where the velocities are high

# Sludge Recirculation

## 7.1 Function

The indivisible combination of the aeration tank, settling tank and sludge recirculation constitutes an “activated sludge biological treatment system”. All three must be fine-tuned to act in unison to produce the desired high level of treatment.

The optimum desired age of the microbes is between 25 to 30 days. At the same time, an STP

needs to maintain a high level of microbes in the aeration tank. Both these objectives are achieved by recirculating the sludge from the settling tank, and also bleeding out of excess microbes from the system at regular intervals.

To illustrate by a simple example: if the total biomass inventory in the system is 100 kg, and daily bleed/ wasting rate is 4 kg, then the average age of biomass in the system is 25 days.

## 7.2 How It Works

A typical pair of pumps (working and standby) is shown below:

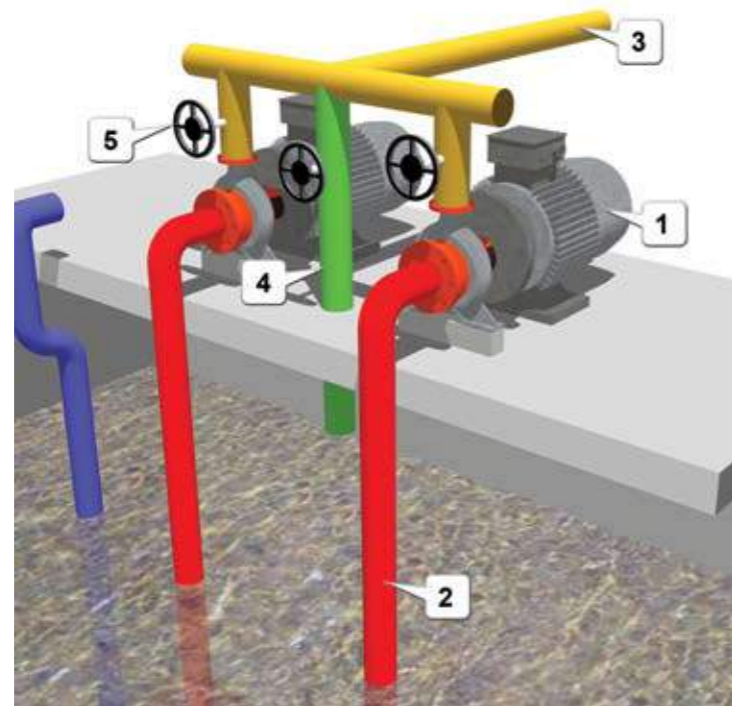

**Note:**

The example shows the pipelines in different colors only for illustration purposes. In actual practice, no such color-coding is followed.

SL	Remarks
1	There are two identical <b>pumps</b> . Controls ensure that only one pump can run at a time.  The sludge from the sludge hopper of the clarifier is taken by gravity into a sludge sump, from where the pumps return the sludge to the aeration tank.
2	Both pumps have independent <b>suction pipes</b> <ul style="list-style-type: none"> <li>It is not desirable to have a common suction pipeline, because if it fouls up, both pumps will have to be shut down.</li> <li>The pipes must not have foot-valves, because the foot-valves would get jammed frequently.</li> <li>The inlet pipes extend almost to the bottom of the tank</li> </ul>
3	The delivery pipes from both pumps are combined in a π-shaped header.  A <b>delivery pipe</b> takes sludge from this header to the aeration tank.
4	The <b>bypass pipeline</b> returns some sludge back to the sludge-holding tank.
5	<b>Valves</b> fitted on all three pipelines serve different purposes: <ul style="list-style-type: none"> <li>The valve on the bypass line is adjusted to “waste” the excess capacity of the working pump. (The delivery pipeline (3) always carries sludge at the designed flow rate, to achieve the desired MLSS in the aeration tank.)</li> <li>The valve on the delivery pipe is closed off when the corresponding pump is removed for repairs. This prevents sludge coming from the other pump from coming out.</li> </ul>

## 7.3 Design Criteria

Sludge recirculation rates are typically between 50 % to 100 % of the throughput rate of sewage in the STP. Hence, in a majority of cases, the capacity and specifications of the raw sewage lift pumps are replicated for this duty as well.

## 7.4 Construction And Engineering

The engineering principles prescribed for the raw sewage lift pumps (see section 4.3) apply to the sludge recirculation pumps as well.

Providing an intermediate sludge sump (between the clarifier and the recirculation pumps) to collect sludge from the bottom of the clarifier tank is preferable to directly connecting the pump to the sludge pipe of the clarifier: This strategy enables control of the recirculation sludge rate, without having to throttle the pump, thereby reducing pump-maintenance costs and extending life of the pumps.

Typically in small plants (say up to 150 m<sup>3</sup>/day) 5-10 m<sup>3</sup>/hr of air is sufficient to lift sludge in a 2”-3” dia sludge pipe, and deliver it back to the aeration tank. Note that air-lift pumps work well only when the submergence is high (i.e., when the mouth of the airlift pump is deep inside the sewage) and the delivery head is small (i.e., when the Aeration tank’s top is not much above the top level of the settling tank). In other words, the water level difference between the Aeration Tank and Settling Tank must not be excessive; otherwise the pump will not be able to lift the sludge, and thus the recirculation will stop.

## 7.5 Operation And Maintenance Considerations

Considerations here are identical to those specified for the raw sewage lift pumps (see Section 4.4).

The manufacturer's O&M manual must be followed with diligence.

Ensure discharge of sludge recirculation into the aeration tank is visible and can be monitored

In addition, if an intermediate sludge sump is provided, it is advisable to force-flush the sludge line of the clarifier at frequent intervals, so that the pipe remains clear at all times, and incidence of choking is minimized.

## 7.6 Troubleshooting

Problem	Cause
Excessive noise	Poor engineering/maintenance
Excessive vibration	Poor engineering/maintenance
Overheating	Poor maintenance
Loss in efficiency of pumping	Poor maintenance

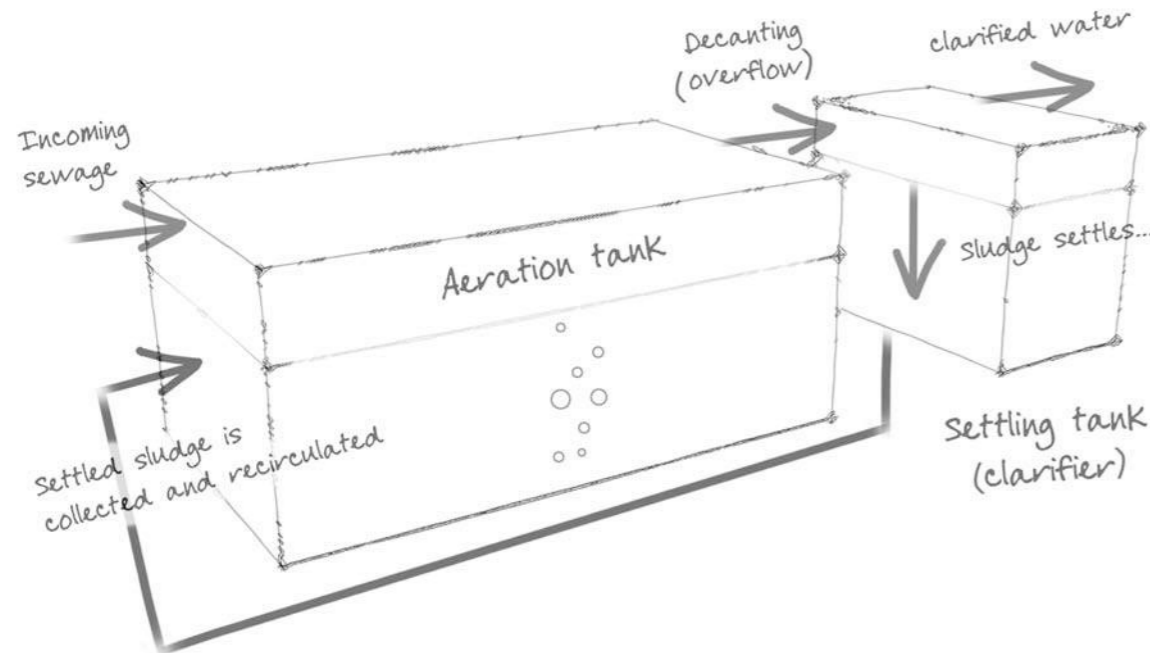

## Clarified Water Sump

### 8.1 Function

Overflow water from the clarifier is collected in an intermediate **clarified water sump**. This sump acts as a buffer tank between the secondary and the tertiary treatment stages in an STP.

In a well-run STP, the treated water quality at this stage is good enough for reuse on lawns and gardens with sufficient disinfection, and water for garden use may be directly taken from this sump, without having to overload the tertiary units.

Also, during lean inflow periods to the STP, backwashing of the filters is carried out. At this time, this tank must hold sufficient buffer stock of water for backwash purposes.

### 8.2 Design Criteria

Any sump tank that serves pumps should have a minimum retention period of 30 minutes, so that only under extreme negligent operations, the sump may overflow, or the pump may run dry.

In addition, the tank must hold enough water to backflush the filters fully. Thus it is prudent to provide a retention time of 2-3 hours of average hourly flow in the STP.

Despite best design, trace quantities of solids always escape the clarifier into this tank. This means presence of live bacteria in this tank. Therefore, it is advisable to aerate this tank, in order to keep the bacteria alive and keep the water fresh.

The air bubbles also serve another purpose: The compressed air keeps these solids in continuous suspension by constantly agitating the water. This prevents the solids from settling at the bottom of the sump and accumulate there. (Settled bacteria will eventually starve and die, as this tank does not have enough food for them. That would turn the contents of the tank septic.)

### 8.3 Construction And Engineering

The tank should be able to properly feed the suction pipeline of the filter feed pumps.

Minimum aeration with coarse bubble diffusers is recommended in this tank to prevent settling of the trace amounts of suspended solids slipping through the settling tank.

It should be possible to clean and maintain the diffusers with ease.

### 8.4 Operation And Maintenance Considerations

There are no special requirements, as this tank plays a passive role in STP functioning.

In general, look after aeration, and inspect the tank periodically for sediments. Remove sediments as required.

### 8.5 Troubleshooting

Troubleshooting in this unit of the STP is not called for due to its passive role.



# Filter Feed Pumps (FFP)

## 9.1 Function

Filter feed pumps are used to take the water from the clarified water sump and pass it through the pressure sand filter and activated carbon filter installed in series.

## 9.2 Design Criteria

Capacity of the filter feed pumps may be chosen keeping in view the desired number of hours of operation of filters (if not the standard 20-22 hours of operation). In this case, the capacity of the intermediate clarified water sump also needs to be enhanced accordingly.

The discharge head of the filters may be specified at 1.5 - 2 kg/cm<sup>2</sup>, to overcome the pressure differential across the two filters under the worst condition (which is just before backwashing or backflushing the filters).

## 9.3 Construction And Engineering

The filter feed pumps may be selected either to be of the open impeller type (more efficient) or, we may fall back upon the trusted non-clog, solids-handling (NC-SH) type of pump selected for raw sewage lifting (see Section 4.4).

The option is left entirely to the designer/ engineer, provided the rest of the STP has been designed and engineered to the satisfaction of a purist.

## 9.4 Operation And Maintenance Considerations

- Switch between the main and standby pump every 4 hours (approximately).
- Check oil in the pump every day; top up if necessary
- Check motor-to-pump alignment after every dismantling operation
- Check condition of coupling and replace damaged parts immediately
- Check for vibrations and tighten the anchor bolts and other fasteners
- Check condition of bearings, oil seals, mechanical seal and replace if necessary
- Completely drain out oil and replace afresh as per manufacturer's recommendation
- Always keep safety guard in its proper position
- Follow the LOTO safety principles<sup>20</sup> while performing maintenance activities
- Ensure discharge of raw sewage into the aeration tank is visible and can be monitored
- Maintain the flow rate at designed level (no tampering with the bypass valve)
- Follow the manufacturer's O&M manual diligently.

## 9.5 Troubleshooting

Problem	Cause
Excessive noise	Poor engineering/ maintenance
Excessive vibration	Poor engineering/ maintenance
Overheating	Poor maintenance
Loss in efficiency of pumping	Poor maintenance

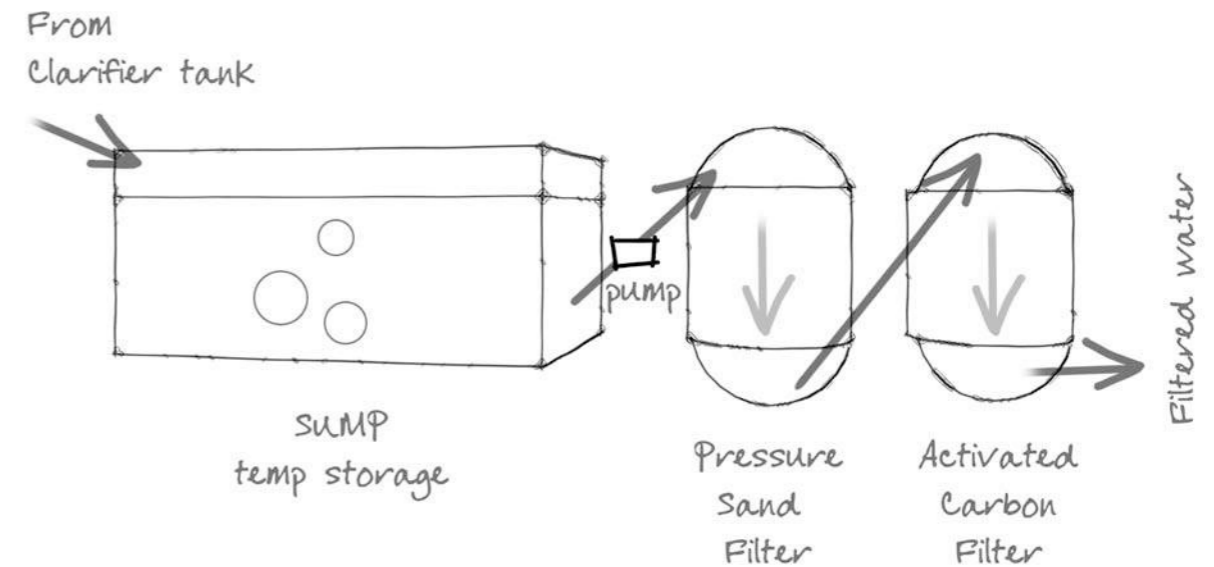

<sup>20</sup> See [http://en.wikipedia.org/wiki/Lock-out\\_tag-out](http://en.wikipedia.org/wiki/Lock-out_tag-out)

# Pressure Sand Filter (PSF)

## 10.1 Function

The pressure sand filter (PSF) is used as a tertiary treatment unit to trap the trace amounts of solids which escape the clarifier, and can typically handle up to 50 mg/l of solids in an economical manner.

This unit is essentially a pressure vessel that is filled with graded media (sand and gravel).

The water filtered with PSF is passed on to the next stage in the STP chain: the Activated Carbon Filter.

## 10.2 How It Works

The upper layers of the sand perform the actual filtration function. The gravel layers merely provide physical support to the upper sand layers.

The sand used in the PSF is not ordinary construction sand: It has particle size in a specific range, and is specially sieved for this purpose.

Think of a sand filter as a 3D (“in depth”) filter, as compared to planar filters like a tea bag or tea strainer. Here, the filtration occurs along the entire depth of the sand layer. The solid particles in the water get entrapped and enmeshed in the spaces between the sand particles.

Gradually, the space between sand particle gets filled with incoming solids. This blocks the passage of water through the sand layer. As a result, the pressure at the outlet drops rapidly<sup>21</sup>, and wastes the pumping power, and reduces the throughput of the filter.

When the pressure drops beyond a limit, the sand is cleaned by backwashing of the filter (backflushing) with water, in which water is passed in the reverse direction (from outlet to inlet). This process agitates, fluidizes and expands the sand bed. The backwash water carries away the lighter pollutant solid particles as backwash waste.



## 10.3 Design Criteria

A good average design filtration rate is 12 m<sup>3</sup>/ m<sup>2</sup>/hr of filter cross-sectional area, and most filters used in STP applications are designed on this basis.

## 10.4 Construction And Engineering

The Filter vessel is designed as a pressure vessel (it consists of a straight cylindrical shell, with convex dish-shaped ends welded to the top and bottom). A typical vessel is designed to withstand a pressure of 5 kg/cm<sup>2</sup>.

In small diameter vessels, it is customary to provide a bolted dish at the top for ease of maintenance. In large filters, a manhole of > 0.6 m dia is provided at the top. A hand-hole of > 200 mm dia is provided at the bottom of the cylinder, to facilitate removal of media from the vessel at the time of servicing.

A set of pipes, valves, bypass line, backwash waste line etc. are also provided to facilitate operations such as filtration, bypass (during servicing), backwash etc. Pressure gauges are provided at the inlet and outlet, to monitor the pressure drop across the filter.

The shell height typically varies between 1.2 m to 1.5 m in small plants. Graded pebbles ranging from 0.5” to 1” are filled as bottom layers in the filter, up to a depth of nearly 0.5 -0.6 m. The top layers consist of the filtering sand media (Coarse and fine sand) to a depth of 0.6 – 0.7 m. A freeboard of nearly 0.3 m above the level of sand may be provided (to allow for expansion of sand during backwash).

A great majority of filters operate in the downflow mode (water flowing in top-to-bottom direction). Necessary appurtenances are provided at the top for distributing the inflow uniformly across the cross-sectional area of the filter: similarly, a pipe manifold with laterals is fitted at the bottom as the underdrain system.

(Without these structures, the water flow inside

the filter will be restricted to the center line; and the media placed near the wall of the tank will not contribute to the filtering action.)

These good engineering practices ensure optimum filtration efficiency by avoiding short circuiting of flow inside the filter, and also minimizing pressure loss in the filter due to sudden expansion/ constrictions in the fittings.

## 10.5 Operation And Maintenance Considerations

The operations essentially consist of a long filtration run, followed by a short backwash sequence.

The filter needs backwash when the pressure drop across the filter exceeds 0.5 kg/cm<sup>2</sup>.

However, it is a good practice to backwash once in a shift, irrespective of the actual amount of pressure loss. A five to ten minute backwash will typically rid the filter of all accumulated muck.

## 10.6 Troubleshooting

Problem	Cause
Excessive pressure drop across filter	Poor operation/ maintenance
Progressively poor filtration efficiency	Poor operation/ maintenance
Very low pressure drop across filter	“Mud balls” formed in filter, discrete sand particles have agglomerated, leading to poor filtration

<sup>21</sup> Stated differently, the pressure-drop across the filter rises sharply

# Activated Carbon Filter (ACF)

## 11.1 Function

An activated carbon filter, like the Pressure Sand Filter, is a tertiary treatment unit. It receives the

water that is already filtered by the Pressure Sand Filter and improves multiple quality parameters of the water: BOD, COD, clarity (turbidity), color and odor.



## 11.2 How It Works

This filter uses the adsorption action of activated carbon.

Activated carbon is typically manufactured from coconut shell or charcoal, the “activation” process creating a highly porous material with a very large surface area. Organic pollutant molecules are physically adsorbed and held fast within the catacomb-like porous structure of the activated carbon. Granular activated carbon is typically used for this purpose.

The water filtered by the Pressure Sand Filter enters the Activated Carbon Filter.

Unlike in the case of the sand filter, trapped molecules in the carbon cannot be backwashed and got rid of. Hence, activated carbon in the filter has a finite capacity to adsorb and hold the pollutants, after which the carbon is said to be exhausted. The exhausted material is removed from the filter and disposed off: Fresh activated carbon is charged in the filter.

## 11.3 Design Criteria

Very precise design criteria are available for design of activated carbon columns (adsorption isotherms, kinetics of mass transfer between the liquid and solid phase, breakthrough curves etc.). For everyday applications, however, the simplified rules used for the sand filter have been found to be adequate.

However, we recommend that the diameter of the activated carbon filter be selected to be 25% larger than the sand filter (SPF) to reduce the frequency of servicing.

## 11.4 Construction And Engineering

Construction and engineering of the Activated Carbon Filter is similar to the PSF. In addition, on the inside of the filter, epoxy paint coating is recommended due to both the abrasive and corrosive nature of Activated Carbon.

## 11.5 Operation And Maintenance Considerations

Just as the PSF, the ACF also needs to be backwashed, albeit at a lesser frequency to dislodge any solid particles trapped by simple filtration action.

When the carbon gets exhausted (indicated by no improvement in water quality across the ACF), fresh carbon needs to be filled into the filter.

## 11.6 Troubleshooting

Problem	Cause
Excessive pressure drop across filter	Poor operation/ maintenance
Treated water smells, or has a color	Carbon life exhausted (change)
Poor BOD/COD	Carbon life exhausted (change)
Black carbon particles in outlet	Poor quality of granular carbon

# Disinfection Of Treated Water

## 12.1 Function

The treated water is disinfected to destroy and render harmless disease-causing organisms, such as bacteria, viruses, etc.

The most common methods of disinfection include Chlorination, Ozonation and UV radiation.

Of these, Chlorine finds widespread application. The primary action of the chemical involves damaging the cell wall, resulting in cell lysis and death.

In most STPs, the common form of Chlorine used is Sodium Hypochlorite (Hypo) available commercially at 10-12 % strength, being safe, easy to handle and having a reasonable shelf life.

## 12.2 Design Criteria

Efficiency of disinfection is dependent both on the residual concentration of the chemical used, as well as the contact time, a factor measured as R x T. Generally, a contact time of 20-30 minutes is recommended to achieve over 99 % germicidal efficiencies.

## 12.3 Construction And Engineering

The Chlorine disinfection system consists of a Hypo-holding tank (its size depends on the flow rate of the STP) and an electronically metered dosing pump. Hypo solution of desired concentration is prepared in the tank. The dosing rate is set in the metering pump as per the desired Chlorine dose rate, typically 3-5 PPM. Hypo solution is dosed at the outlet of the ACF, online, so that adequate mixing of Hypo with the treated water is achieved.

## 12.4 Operation And Maintenance Considerations

- Prepare fresh Hypo solutions every day in the day tank
- Shelf life of over 2 months is not recommended, especially during summer
- Store Hypo in a cool place
- Study Material Safety Data Sheets of Hypo and follow instructions
- Periodically check available Chlorine strength of Hypo
- Check and record Residual Chlorine concentration every day

## 12.5 Troubleshooting

Problem	Cause
Inadequate Chlorine residual in treated water	Poor operation/ poor quality chemical
Fishy smell in treated water	Excessive chlorination

# Excess Sludge Handling

## 13.1 Function

Biological treatment of wastewater produce excess biological solids due to the growth and multiplication of bacteria and other microorganisms in the system. The excess biomass thus produced needs to be bled out of the system, and disposed off efficiently.

This is a five-step process: sludge removal, storage, conditioning, dewatering and disposal.

Sludge is removed (“bled”) from the system from the sludge recirculation pipeline (through a branch).

The sludge is in the form of a thick slurry. It is taken into a sludge-holding tank, and kept under aeration (to prevent the living organisms from putrefying) until dewatering operations can be carried out.

Before dewatering, polymer or other chemicals may be added for conditioning the sludge, to facilitate the process. Sludge is then dewatered in a filter press/ Sludge bag/ centrifuge.

## 13.2 Design Criteria

The quantity of excess sludge generated in the STP is dependent on various factors including the BOD concentration, MLSS levels, temperature etc. The F/M loading rate is however is the factor which chiefly determines the amount of excess solids produced. Sufficient data are available in literature in graphical form for determination of this number. A typical figure for use in India is between 0.20 to 0.25 times (on dry mass basis), kg of BOD removed in the aeration tank, in extended aeration systems with low F/M.

Since the excess sludge is available in slurry form from the sludge recirculation line, the slurry consistency may be taken to be between 0.8 to 1.0 %.

Simple arithmetic using the above two numbers

gives the quantity of excess sludge to be handled per day in m<sup>3</sup>/day.

## 13.3 Construction And Engineering

We will discuss two different methods of handling the dewatering system:

- Plate-and-Frame Filter press
- Bag-type dewatering

### 13.3.1 Plate-and-Frame Filter press

The Plate-and-Frame Filter press is the most commonly used method of dewatering the sludge. It consists of three to four parts:

- Sludge-holding tank with aeration/ mixing
- Polymer solution-preparation tank and dosing (for conditioning the sludge)
- High-pressure filter-press feed pump
- Plate-and-frame filter press

The polymer solution tank must be of sufficient capacity to hold 0.1 % solution of polymer to condition one batch of excess sludge: Typically, polymer requirement is between 1-2 % of the excess sludge on dry weight basis.

The sludge-holding tank must be of sufficient capacity to accommodate the combined volume of (a) the excess sludge to be dewatered in a single batch, and (b) the polymer solution that is added.

The high-pressure filter press-feed pump (4 – 5 kg/cm<sup>2</sup> pressure) must be selected to dewater a single batch of excess sludge within 3-4 hours of filter press operation.

A typical press is shown on the next page.

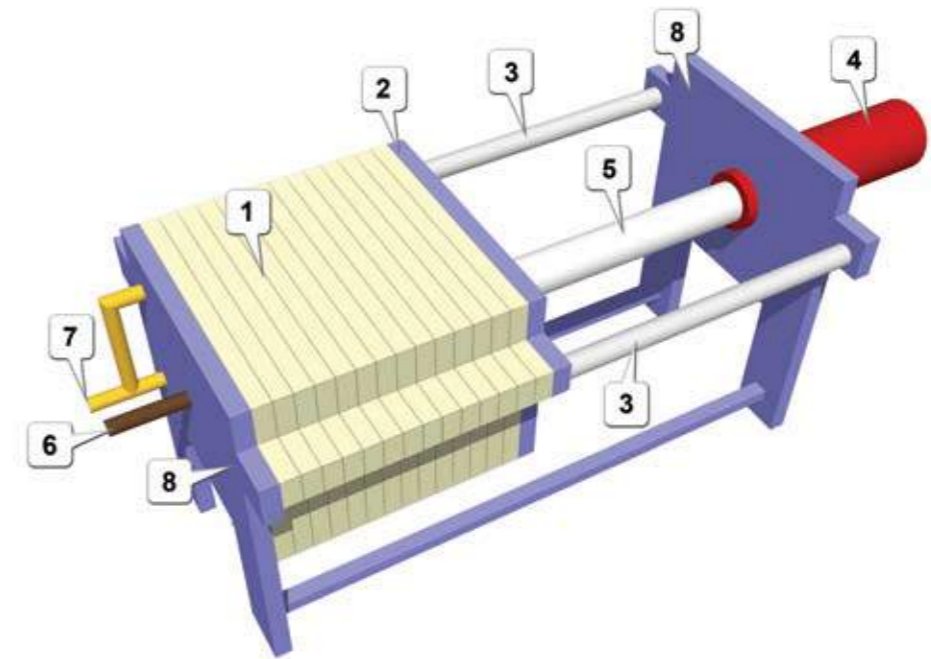

SL	Remarks
1	The press makes use of multiple <b>filter plates</b> . Each plate has indentations and recesses on the sides, such that when two plates are pressed together, a hollow chamber is formed between the plates. The dewatered sludge settles in this hollow part to form a brick (also called “cake”).
2	The <b>end-plate</b> is a solid plate used to press the filter plates (1) together.
3	All the filter plates and the end-plate have “wings”, which rest on these two <b>rails</b> . All the plates hang on the rails, and they are designed to easily slide along the rail when pushed.

	The figure shows a <b>hydraulic jack (4)</b> that extends and retracts the <b>plunger (5)</b> . The job of the plunger is to tightly press the filter plates (1) against each other, so that the slurry (which is injected in the press under high pressure) does not leak from the joints between the filter plates. In smaller filter presses, the electric jack and plunger are replaced with a large screw that is turned manually with a large wheel.
6	The <b>inlet pipe</b> brings the excess sludge slurry from the screw pump (not shown in the figure). The slurry travels the path of least resistance and fills up the cavities between the <b>filter plates (1)</b> . All cavities are lined with a filter cloth.

<p><b>7</b></p>	<p>The liquid in the slurry (called “filtrate”) can pass through the cloth, while the thicker paste-like sludge (mainly bacterial flocs and some solids) cannot pass through the cloth.</p> <p>The filtrate travels to the outlet ports at the top and bottom of the plate, and from there it is discharged through the <b>filtrate discharge pipe</b>.</p> <p>The solids remain in the cavity between the plates. Typical thickness of cake in the chamber is 2 to 5 cm,</p> <p>A freshly produced cake has a moisture content of between 70 – 75 %. Note that it is impossible to achieve a bone-dry cake even after prolonged air-drying: The moisture content would not drop below 50%.</p> <p>In any case, the main use of the cake is used for making compost, in which case the sludge has to be moistened once again. Therefore the cake is usually not dried further.</p> <p>Once the filtrate stops coming out of the discharge pipe (7), the jack (4) is deactivated, which retracts the plunger (5). Now the filter plates (1) are slid apart on the rails (3).</p> <p>As soon as the plates separate, the cakes fall down in a basket placed below the press.</p> <p>Now the press is ready for another cycle.</p>
<p><b>8</b></p>	<p>The work-bench is simply a support structure for the parts described above.</p>

### 13.3.2 Bag-type dewatering

This contraption actually is an imitation of our daily tea-strainer! In fact, once the sludge is strained, it does look remarkably like used tea powder (not the CTC or whole tea leaves, but the lowly tea dust.)

The key factor that allows this method is that the flocs of bacteria are globular with 2-3 mm diameter. These flocs can be easily trapped with a laminated poly bag. These bags are used to transport sugar, fertilizer and other foodstuff, and at the end of the cycle, they are discarded. These used bags are available in secondary market at very cheap rates.

The equipment is very simple, as shown on facing page: A rustproof Stainless Steel table is manufactured with provision to hang 2-4 bags. The sludge is poured in each bag, and just like tea-strainer, the water drains out.

SL	Remarks
1	The <b>stainless steel table</b> allows splashing of water without getting rusted.
2	The <b>openings</b> have a collar beneath, where the bags can be clamped
3	The <b>excess sludge pipeline</b> brings sludge from the settling tank.
4	The <b>valves</b> can be used to regulate the flow rate, and also to turn off if there is no bag beneath.
5	The <b>laminated poly bags</b> capture the floc, but allow the water to run.
6	The <b>stainless steel collection tray</b> collects the water (and fine sediments)
7	The <b>stainless steel grill</b> supports the bags and allows the water to fall through
8	The <b>collection pipe</b> takes the filtrate back to the Equalization tank.  (Sump and pump required for this purpose are not shown).

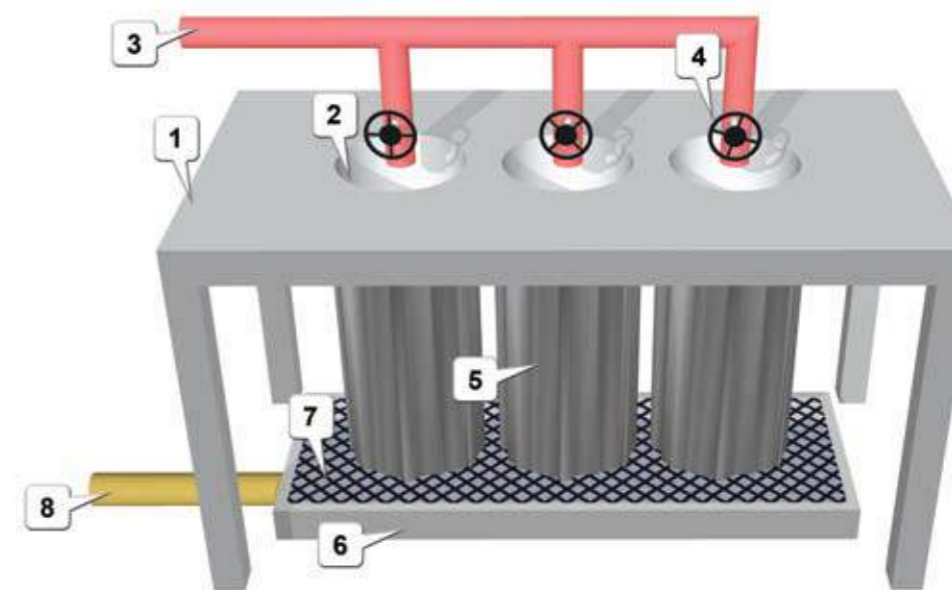

However, because the sludge is not squeezed (as in the frame-and-plate press), the bag remains wet. So, after the water stops dripping, the operator has to close the bag and place it on airing racks to let it dry for several days.

In fact, if the dewatered sludge is to be used as compost, then it need not be dewatered further: The moist sludge can be directly used as an ingredient!

### 13.4 Operation And Maintenance Considerations

Typically, in small plants, the filter press may be sized for a single batch operation per day. In large plants, three batches per day, one per shift, is the norm.

Fresh sludge (not more than a day old), kept fully aerated and mixed (agitated), dewateres easily in

the filter press. Hence, sludge must not be stored in the holding tank for longer durations.

The desired quantity of polymer needs to be added 15 - 30 minutes before the dewatering operation. Filter press operation is carried out over 3 - 4 hours, or when filtration ceases.

After every dewatering operation, the filter cloths must be thoroughly cleaned, so that clogging in the pores of the woven polypropylene filter fabric is avoided. Periodic cleaning of filter cloth with Hypo solution will also prolong the life of cloth.

When the filtration process becomes excessively slow, it is time to replace the filter cloth with a fresh set.

Normal maintenance as prescribed by the manufacturer may be practiced for the high pressure helical screw pump. Care must be taken not to damage the rubber stator of the screw pump by dry running of the pump. It is generally preferable to locate the pumps such that positive suction is enabled.

## 13.5 Troubleshooting

Problem	Cause
Filter press does not dewater the slurry sufficiently quickly	Poor design/ engineering
Dewatering is very slow	<ul style="list-style-type: none"> <li>Oily / slimy sludge,</li> <li>Filter cloth is clogged,</li> <li>Improper conditioning</li> <li>Incorrect filter cloth fabric</li> </ul>
Insufficient pressure developed	<ul style="list-style-type: none"> <li>Rubber stator of screw pump worn out</li> <li>Steel rotor damaged</li> </ul>

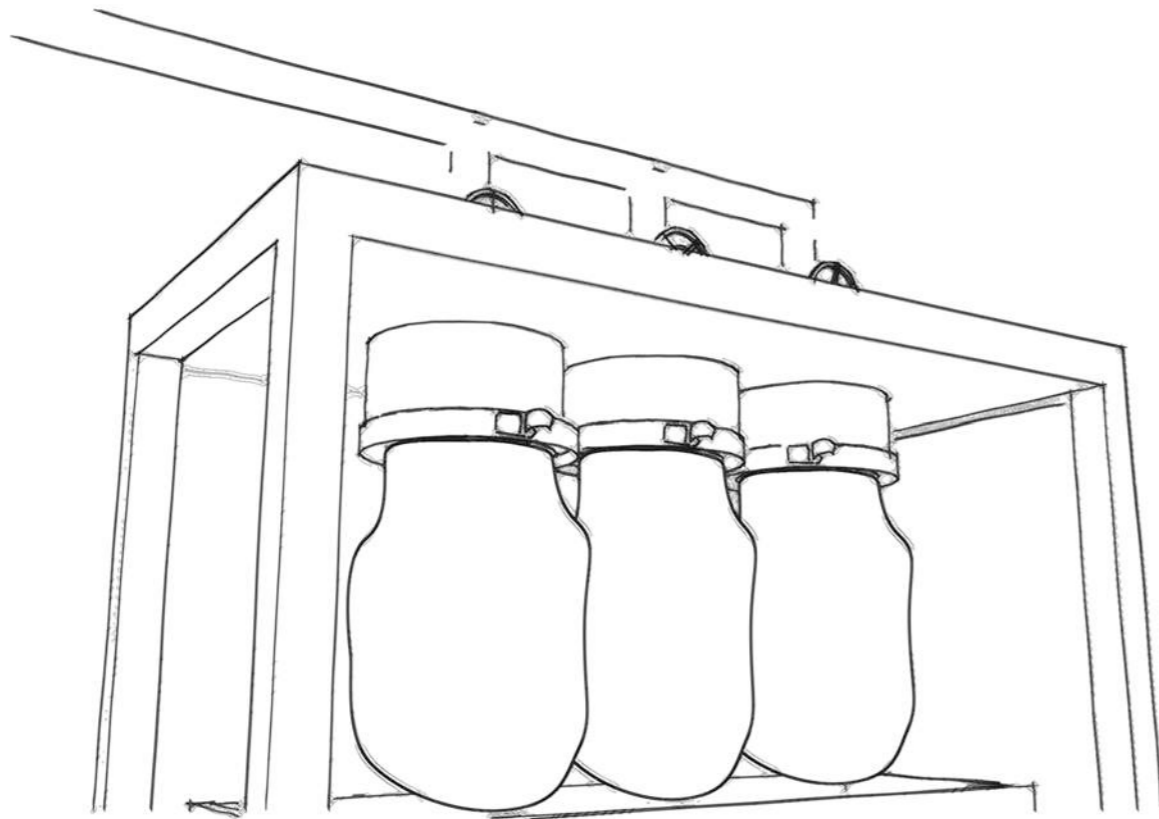

## Miscellaneous Considerations

- Genset backup power to run the entire STP in case the mains electricity line fails
- Design and engineer the STP to be operator-friendly
- Design and engineer the STP for the operator's safety, health and hygiene
- Adequate illumination in STP if in a room, or basement
- Totally covered, underground STPs are neither operator-friendly, nor maintenance-friendly
- Adequate exhaust and ventilation system to be provided for operator comfort, health and hygiene
- Without proper exhaust/ ventilation in enclosed spaces, Carbon Dioxide accumulates, gets converted to Carbonic acid and corrodes metallic parts in the STP. Carbonic acid also depresses pH of the wastewater, thus affecting treatment performance
- Provide safe and comfortable access to all units in STP for monitoring, operation, and maintenance
- Prepare and maintain a Standard Operating Procedure for the STP and train all operators to follow those procedures
- Prepare and maintain an operating log book for all activities in the STP
- Prepare and maintain a mechanical checklist for routine preventive maintenance
- Prepare and maintain a History Sheet for each critical equipment in the STP
- Prepare and maintain a chemicals/ consumables stock register
- Periodically check and validate all log books, checklists etc.
- Provide a Water meter at the outlet of the ACF to monitor average daily throughput of the STP
- Ventilation system: Generally 10-12 air changes per hour should give good ventilation<sup>22</sup>. The air change is calculated based on the open/ vacant head space of the underground/ basement room. There must be a fresh air fan (forced draft) and an exhaust fan (induced draft), with two separate ducting systems.
- If the induced draft fan is designed for a slightly higher capacity than the fresh air fan, then the room will always be under a slight negative pressure, and gases will not escape the room as fugitive emissions.

<sup>22</sup> For example, if the STP room has 5 m<sup>3</sup> of free space (not counting the volume of the tanks), then the circulation system should have minimum handling capacity of 50 m<sup>3</sup>/Hr.

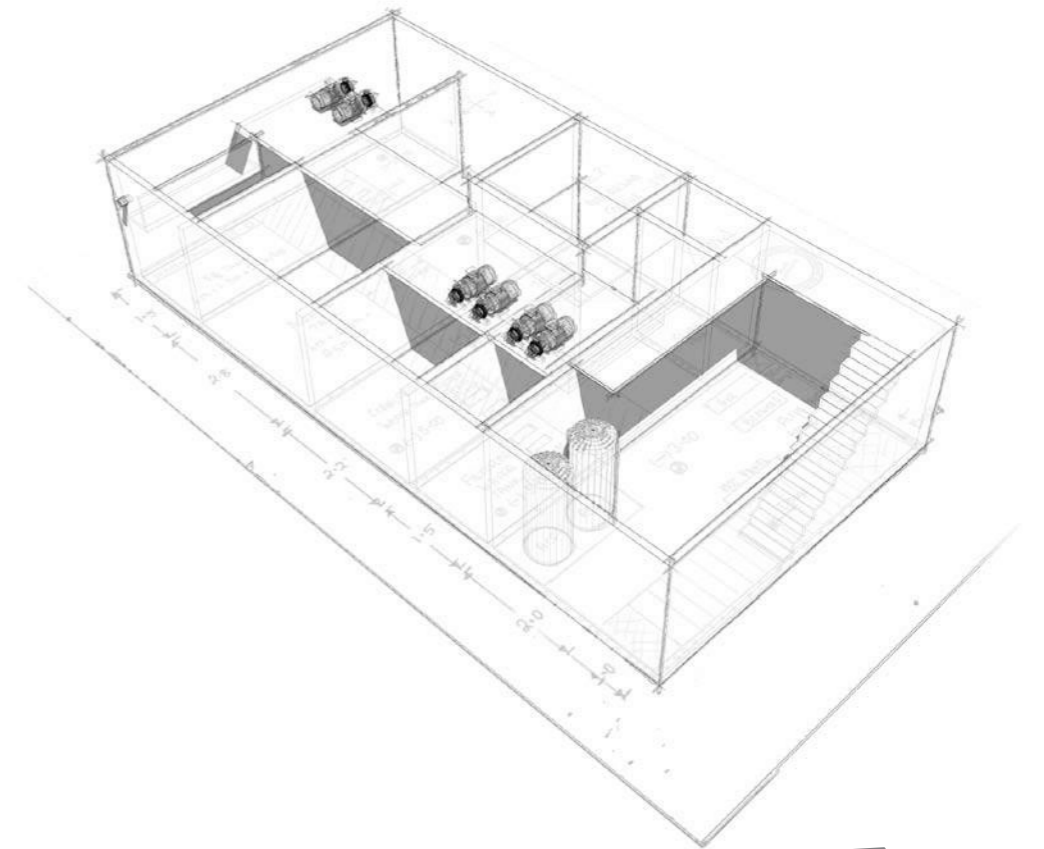

# Design and Engineering



# STP Design Process

In the previous chapters, the STP units were introduced one by one. This chapter provides the complete design process (calculations) for all units of a typical STP.

In the subsequent two chapters, we will see the engineering and operational aspects of the STP in detail.

## Design process overview

Before starting design, let us review how an extended aeration type STP functions.

1. Domestic sewage is typically pure water that is laden with a small amount of biodegradable pollutants. The STP uses bacteria in the aeration tank<sup>23</sup> to digest this biodegradable material. Therefore the incoming sewage must remain in the aeration tank long enough to let the bacteria complete the digestion process.

So the first task before the designer is to retain the sewage long enough in the aeration tank.

2. The bacterial population needs Oxygen to survive.

So the second task before the designer is to provide adequate Oxygen.

3. The bacterial mass (called “activated sludge”) is recycled and retained in the aeration tank, while the treated water overflows from the clarifier tank. This clarified water is further filtered, disinfected and reused for non-potable purposes (toilet-flushing, washing cars, gardening, etc.). A sizable fraction of treated water remains unused, which is released in nature.

So the third task before the designer is to clarify, filter and disinfect the water.

4. The bacteria breed in the aeration tank, which increases the sludge volume constantly. Secondly, the bacterial population is the most vigorous when average age of the bacteria in the tank is maintained at 25 days. Both these purposes are achieved by bleeding off the excess sludge periodically. (The discarded sludge is used as organic manure).

So the fourth task before the designer is to provide a system for disposal of excess sludge.

The designer starts by estimating the amount of sewage generated. This is the basis for calculating all physical properties of the STP (tank volume, pump capacity, etc.)

Then the designer estimates the amount of nutrition (carbohydrates, proteins, etc) present in the sewage. This is called “food” (which the bacteria have to digest). For a given type of use (residential/office/factory) and scale of operation, the amount of food can be estimated with a fair accuracy (using empirical data).

The next step is to find the amount of bacteria needed to digest this amount of food. Based on this figure, the subsystems needed to handle the bacteria are designed (amount of oxygen needed, amount of excess sludge to be handled, etc.).

<sup>23</sup> The clarifier tank is just a mechanism to recover the bacterial flocs and return them to the aeration tank within one hour. You can think of it as a strainer.

The designer has to consider the following main influencing factors:

Parameter	Typical range	Remarks
F/M ratio	0.05 to 0.30	In Extended Aeration-type STP, this range is 0.10 to 0.12.
Oxygen requirement	1.0 to 1.8 kg/kg BOD	Providing oxygen consumes energy. Lower is better.
Excess sludge	0.1 to 0.25 kg/ kg BOD	How much sludge is to be disposed off. Lower is better.
Efficiency	70 % to 95 %	The percentage of biodegradable matter broken down in the STP. Higher is better.

The F/M ratio is the main choice available to the STP designer. However, he has to keep in mind that any ratio he chooses will have a major effect on the STP, as shown below:

### Effects of F/M ratio

F/M	Effect			
	Oxygen Requirement	Excess sludge Production	Treatment Efficiency (%)	Aeration Tank volume
LO	HI	LO	HI	HI
MED	MED	MED	MED	MED
HI	LO	HI	LO	LO

**Note:**

The fonts show whether this is a **good**, **neutral** or **bad** outcome

The first row of the table is explained below as an example:

If he chooses a **low** F/M ratio (a higher amount of bacteria in the aeration tank), the following things happen:

1. The higher amount of bacteria need more oxygen (which is **bad**, because providing more compressed air requires more energy)
2. A lower amount of excess sludge is produced (which is **good**: It saves energy needed to dewater the sludge; and saves the expenses of disposing the excess sludge).
3. More bacteria are able to digest a larger percentage of the sewage (which means that a lesser amount of biodegradable matter remains in the treated sewage. When this sewage is released to nature, it would demand lesser amount of Oxygen from lakes and rivers, which is **good**.)
4. More bacteria means the aeration tank has to accommodate more bacterial flocs (apart from the incoming sewage). This is **bad**, because it requires a larger tank size.

The following table shows the consequences of imbalance in food, microorganisms and oxygen. In each case, only one factor is shown out of balance: the other two are assumed to be as per design.

Parameter	Too low	Too high
Microorganisms (Bacteria)	1. The STP is overloaded 2. Sewage is treated only partially	1. The STP is underloaded 2. Filamentous growth 3. Gradual failure of plant
Oxygen	1. Underaeration 2. Partial treatment of sewage 3. Filamentous growth 4. Gradual failure of plant	1. Overaeration 2. Pinpoint flocs 3. Poor settling (chokes the filters) 4. Gradual failure of plant
Food	1. Filamentous growth 2. Gradual failure of plant	1. The STP is overloaded 2. Partial treatment of sewage 3. Filamentous growth 4. Gradual failure of plant

Such unbalanced conditions cannot be sustained over long periods of time: It will lead to eventual failure of STP.

Therefore the designer also has to do a fine balancing act between these factors.

**Note:**

*That developing a new culture of bacteria in the required large quantities takes time. So, if an STP fails, it may take several days to recover. Till the STP recovers, the users have to make alternative arrangements to treat the sewage (such as pumping the raw sewage out and ferrying it to a public STP.) This operation is extremely expensive. Therefore a failed STP can be devastating in monetary and environmental terms.*

## Design Criteria for STP

Item	Design Criteria Used
Bar screen	<ul style="list-style-type: none"> <li>Flow velocity thru screen Max. 0.3 m/sec</li> <li>Solids to be captured : 12 mm or more</li> <li>Placement of a coarse screen before the fine screen will be beneficial</li> </ul>
Equalization tank	<ul style="list-style-type: none"> <li>Minimum detention time: 4-6 hours (to handle peak flow)</li> <li>Air for mixing and avoid settling and septicity</li> <li>Air flow: 1 m<sup>3</sup>/ m<sup>3</sup> of tank volume <b>OR</b> 2 m<sup>3</sup>/m<sup>2</sup> of tank floor (whichever is greater)</li> </ul>
Raw sewage lift pumps	Capacity calculated based on 20-hour/day working of STP, to leave sufficient margin for change over, maintenance, rest period, etc.

<b>Aeration tank</b>	<ol style="list-style-type: none"> <li>Design BOD : 250 mg/L (equalized sewage)</li> <li>Aeration time: 16 Hrs minimum (desirable: 18 hrs)</li> <li>F/M ratio : 0.12 (to achieve over 95 % BOD removal)</li> <li>MLSS : 3500 mg/L</li> <li>Air : 50 - 60 m<sup>3</sup>/Hr/ kg BOD</li> <li>Diffusers : Flux rate 8 – 12 m<sup>3</sup>/ Running meter /Hr (for 90 OD diffuser)</li> </ol>
<b>Secondary Clarifier</b>	<ul style="list-style-type: none"> <li>Overflow rate : 12-18 m<sup>3</sup>/m<sup>2</sup>/Day</li> <li>Detention time : 2.5-3.5 hours</li> <li>Solids loading : 2-3 kg/m<sup>2</sup>/Hr</li> <li>Weir loading : Less than 50 m<sup>3</sup>/Running meter/day</li> </ul>
<b>Pressure sand filter</b>	Loading rate : Less than 12 m <sup>3</sup> /m <sup>2</sup> /Hr
<b>Activated Carbon filter</b>	Loading rate : Less than 10 m <sup>3</sup> /m <sup>2</sup> /Hr Carbon charge : For 6- 8 months replacement
<b>Softener</b>	Design hardness removal from 300 mg/L down to 100-120 mg/L
<b>Hypo dosing</b>	5 PPM dosing, to leave 0.5-2 PPM residual
<b>Excess Sludge</b>	0.20 – 0.25 kg excess solids per kg BOD removed (dry basis)
<b>Sludge conditioning</b>	0.8-1.2 kg lime per kg dry activated sludge 1 – 2 % polymer to sludge on dry weight basis
<b>Filter press</b>	Sufficient wet cake holding capacity based on excess sludge production, as calculated above (For STP size of 400 m <sup>3</sup> /day and above, design for 2 cycles per day)

We will be using three different types of values for the calculations:

- The design criteria (see the table above).
- Fact-based figures for the given complex (e.g. number and type of apartments)
- Assumptions (e.g. water consumption per person per day)

Based on these values, the dimensions for all units of the STP are derived.

- To calculate a parameter, we may use one or more values calculated before that point.
- In the following calculations, the units KLD (kiloliters per day) and m<sup>3</sup>/day are used interchangeably.

We will take an example of a typical apartment complex with 200 3-bedroom apartments, and see how its STP is designed.

## Sewage Quantity (STP Capacity)

The STP must be able to treat all the sewage generated in the complex. That is why we start by calculating how much sewage is actually likely to be generated in the complex.

In general, almost all the water that is used in the kitchens, bathrooms and toilets of the apartments reaches STP as sewage. Only some of the consumed water is lost (e.g. evaporation); and therefore does not get converted in to sewage<sup>24</sup>.

Parameter	Value/Calculation	Remarks
Dwelling type	Residential apartment complex	Commercial and office complexes would have different basis for calculating the water consumption.
Grade	"Superior"	Although such formal profiles do not exist, it helps in assuming certain lifestyle for the residents; which in turn helps in assuming certain parameters (such as daily water consumption rate).
No. of dwellings	200 x 3-bedroom Apt	Figure taken for this example.
Total population	1000	Population assumed at 5 persons per apartment
Diversity factor	90 %	To account for reduction of population due to a few vacant apartments, lesser number of residents in some apartments, etc.
Per capita water consumption	150 LPD	This figure is assumed for "superior" grade apartments <sup>25</sup> (LPD=Liters per day)
Total water consumption	= 1000 x 90 /100 x 150 = 135,000 LPD	= (Population) x (diversity factor) x (per Capita consumption)
Sewage generated	120,000 LPD	The consumptive usage and losses are approximately 10%. The result is rounded off.
<b>Sewage quantity</b>	<b>120 KLD</b>	This figure is the basis for designing all stages of the STP.

### Note:

This 120 KLD is a reference figure, which will be used for designing all stages of the STP.

<sup>24</sup> If the apartment has a swimming pool, it does not contribute to the sewage.

<sup>25</sup> The consumption is more in "Super luxury" and "luxury" grade apartments; and lesser in "mid-level" and "economy" grade apartments. Select this figure carefully; otherwise the STP would be unable to handle the actual quantum of sewage.

## Bar Screen Chamber

The bar screen chamber is the first unit in the STP, so all the incoming sewage passes through its grill. Therefore it should be able to handle the sewage (especially the peak flows) without overflowing.

There are two major factors to be considered:

1. Adequacy of the cross-sectional area of the chamber itself
2. Obstruction posed by the bars of the screen.

The net opening should be adequate to allow proper flow of the sewage (especially during peak inflow).

Parameter	Value/Calculation	Remarks
Average daily flow	120 KLD <sup>26</sup>	Quantity of sewage to be handled by the STP on daily basis (ref. page 82)
Average hourly flow	= 120 / 24 = 5 m <sup>3</sup> /Hr = 5 / 3600 m <sup>3</sup> /sec = 0.0014 m <sup>3</sup> /sec	
Peak hourly flow	= 3 x Avg. hourly flow = 3 x 5 m <sup>3</sup> /Hr = 15 m <sup>3</sup> /Hr	The peak is assumed to be three times the average.
Design flow velocity	0.30 m/sec	This is the optimal velocity: <ul style="list-style-type: none"> <li>• Sewage flowing at a higher velocity will forcibly push the debris through the screen.</li> <li>• Sewage flowing at a lower velocity will leave an excessive amount of sedimentation on the floor of the screen chamber.</li> </ul>
Cross-sectional area of screen channel	= 0.0014 / 0.3 = 0.005 m <sup>2</sup>	Volume/Hr = Cross-sectional area x flow velocity.
Adjust for the flow-area blocked by the bars	= 0.005 m <sup>2</sup> x 1.5 = 0.0075 m <sup>2</sup>	Cross-sectional area is increased by 50% to compensate for the obstruction posed by the bars of the grill.  In general, the multiplication factor is (1+ W/G)  Where- G = Gap between two bars of the screen (here, 10 mm) W = Width of a bar (here, 5 mm)

<sup>26</sup> KLD=Kiloliter per day.

Required minimum dimensions <sup>27</sup>	0.1 m x 0.1 m	This is a comfortable target: Actually it is easier to build larger channels. Also, a larger chamber is easier for the STP operator to clean. These larger chambers can handle much larger peaks in the inflow.
---	---------------	---

## Equalization Tank

The equalization tank must be able to provide the necessary buffer for the fluctuating inflow and provide a steady outflow. It must also keep the sewage agitated and provide sufficient aeration to prevent odor problem.

The following calculations show what type of equalization tank would be required for our STP.

Parameter	Value/Calculation	Remarks
STP quantity	120 KLD =120 m <sup>3</sup> /day	Quantity of sewage to be handled by the STP on daily basis (ref. page 82)
Hourly average sewage inflow	= 120/24 m <sup>3</sup> /Hr = 5 m <sup>3</sup> /Hr	
Equalization tank volume	= 5 x 6 m <sup>3</sup> = 30 m <sup>3</sup>	Tank is designed to hold six hours of average flow. Note that this is the usable volume, and does not include the freeboard.
Freeboard	0.3 to 0.5 m	Selected by convention.
Water depth in tank (excluding freeboard)	2.0 to 2.5 m	The incoming sewage line is already below ground level, and the entire equalization tank has to be located below this pipe. This puts a constraint on the depth.
Tank area	= 30/2 m <sup>2</sup> =15 m <sup>2</sup>	Area = Volume / Depth Select length and width to suit the site conditions
Diffusers required	Select size and number to suit the dimensions of the tank	Typically, a pair of diffusers must fit within the width of the tank. If the tank is not wide enough, the pair may be placed at an angle.  Several such pairs of diffusers are placed along the length of the tank.
Air quantity required	No. of diffusers x 5 m <sup>3</sup> /Hr	Maximum air flux rate per coarse bubble diffuser of 90 OD x 800 L may be taken as 5 m <sup>3</sup> /Hr.

## Raw Sewage Lift Pumps

The raw sewage lift pumps have to handle the entire daily quantity of the sewage. The pumps must be selected to have a little higher capacity, so that we can adjust the flow rate precisely by adjusting the

<sup>27</sup> Note how a tiny bar screen chamber (just 10 cmx10cm) can comfortably serve a 200-apartment complex!

bypass pipeline.

The following table shows the calculations for selecting the correct pumps for our STP.

Parameter	Value/Calculation	Remarks
STP quantity	120 KLD =120 m <sup>3</sup> /day	Quantity of sewage to be handled by the STP on daily basis (ref. page 82)
Pump capacity	= 120/20 = 6 m <sup>3</sup> /Hr	Select a pump that has a little higher capacity, so that a little quantity can be bypassed to achieve the desired net flow rate.  • If the pump capacity is too high, a lot of sewage will have to be bypassed, resulting in waste of energy.
Suction head (m)	Difference in floor level of the equalization tank and suction level of pump	The sewage level in the equalization tank fluctuates throughout the day. The worst-case suction condition exists at late night/ dawn, when the equalization tank is almost empty just before the peak morning inflow starts. That is why the pump must be selected to take care of this suction head.
Delivery head (m)	The difference in top level of aeration tank and delivery level of pump	Select a pump that has the rated capacity at this delivery head.
Total head (m)	= Suction Head + Delivery Head	Select a pump that has the rated capacity at this delivery head.

## Aeration Tank

The aeration system should be able to retain the incoming sewage for a certain time, and also provide sufficient amount of bacteria and oxygen needed to digest the sewage.

The following calculations establish what kind of aeration tank would be needed for our STP.

Parameter	Value/Calculation	Remarks
STP quantity	120 KLD	Quantity of sewage to be handled by the STP on daily basis (ref. page 82)
BOD in sewage <sup>28</sup>	250 mg/L =0.000250 kg/L	Empirical value, for typical Indian domestic sewage. BOD may range from 200-250 mg/L. We have taken the highest (the worst-case) value in the range; so that the STP can deal with lighter loads also.

<sup>28</sup> How to interpret this BOD figure: It means if this sewage is released in nature, it would demand (absorb) 250 mg of Oxygen from the surrounding air/water for every liter of sewage. The idea is to provide that much Oxygen inside the aeration tank, so that the treated sewage would become inert, and when the treated sewage is released in nature, it would not demand any Oxygen from its surroundings.

<b>BOD load/day</b>	= (120 x 1000) x 0.000250 = 30 kg/day	This means the aeration tank has to supply 30 kg of Oxygen every day. (This is the "Food" in the F/M ratio.)
<b>F/M ratio</b>	0.12	This value is taken from the available range of 0.10 to 0.12. The higher limit represents the worst-case scenario (more food in the sewage for the bacteria existing in the aeration tank).
<b>M (Biomass)</b>	= 30 / 0.12 = 250 kg	This means that we need 250 kg of bacterial flocs to digest the sewage,  Note that this is the biomass needed in the aeration tank at any point of time. This figure does not include the mass of bacteria that is in the clarifier tank.
<b>Design MLSS level</b>	3500 mg/L (= 3.5 kg/ m <sup>3</sup> )	The acceptable MLSS range is 3500-4500.  But we chose the lowest MLSS in the range in the range, because it gives us the most conservative size for the aeration tank (see the row below).
<b>Aeration tank volume</b>	= 250 / 3.5 = 72 m <sup>3</sup>	= Biomass / MLSS  Selecting lowest MLSS yields the highest-possible size for the aeration tank. This size will be able to handle higher values of MLSS.
<b>Average retention time</b>	= 72/ 120 x 24 Hrs <b>= 14.4 Hrs</b>	Think of this as =(24/120) x 72.  The first term is the time taken by a unit volume of sewage to exit the aeration tank.  Multiplying this with the volume of the tank gives us average time taken by the present contents of the tank to exit the tank (=average retention time)

We will have to pause here, because we got a retention time of 14.4 hours; compared to our target of 16 hours minimum (preferred: 18 hours). We will have to go back and change a factor till we achieve 16 hours of aeration.

This is a perfect example of an iterative design, which also reinforces the fact that the designer has to make a considered decision based on several site-specific conditions.

So let us examine which of the independent factors can be altered to achieve the desired retention time (Note that the value of that factor must be tweaked within its acceptable range; so as not to upset the delicate balance).

Fortunately, we have found a quick solution: Maintaining a higher population of biomass in the system is a desirable feature, in order to overcome a temporary hiccups in the aeration tank performance (which may be caused by loss of power, equipment malfunction/breakdown, and even a huge surge of sewage).

Therefore, we will choose to introduce a 20 % safety margin, and increase the biomass from 250 kg to 300 kg.

Now we will re-calculate the last two rows of the preceding table with this new value:

<b>Aeration tank volume</b>	= <del>250</del> 300 / 3.5 = 72 86 m <sup>3</sup>	= Biomass / MLSS  Selecting lowest MLSS yields the highest-possible size for the aeration tank. This size will be able to handle higher values of MLSS.
<b>Average retention time</b>	= <del>72</del> 86/ 120 x 24 Hrs = <del>14.4</del> 17.2 Hrs	Think of this as =(24/120) x 86.  The first term is the time taken by a unit volume of sewage to exit the aeration tank.  Multiplying this with the volume of the tank gives us average time taken by the present contents of the tank to exit the tank (=average retention time)

Now our retention time in the aeration tank is within the limits; and we can proceed with the rest of the design.

Parameter	Value/Calculation	Remarks
<b>Depth of aeration tank</b>	= 3.0 m	Select 3 m water depth <sup>29</sup> as a good practical working depth (considering the typical ceiling height available in an STP).  If area is severely constrained, the depth may be increased up to 4.0 m.
<b>Area of aeration tank</b>	= 86/3 = 29 m <sup>2</sup>	Area = Volume / Depth.
<b>Width of aeration tank</b>	3.6 m	This width is ideal to accommodate set of 1m long diffusers
<b>Length of aeration tank</b>	= 29 / 3.6 = 8 m	Length = Area/width
<b>BOD load per hour</b>	= 30 / 22 = 1.36 kg/Hr	= (BOD load per day) / (no. of aeration hours). Assuming 22 hrs of aeration.
<b>Air requirement for BOD</b>	= 1.36 x 60 = 82 m <sup>3</sup> /Hr	60 m <sup>3</sup> /Hr of air per kg BOD is a good, generous figure, resulting from an involved equation, which accounts for a number of variables such as density of air, Oxygen content in air, kinetics of Oxygen transfer from the gas phase to the liquid phase, correction for impurities present in wastewater, etc.
<b>Air requirement for mixing</b>	= 86 x 1.1 = 95 m <sup>3</sup> /Hr	This requirement is @1.0-1.2 m <sup>3</sup> /m <sup>3</sup> of tank volume

<sup>29</sup> Water depth is measured from bottom of the tank to the top-edge of the weir. The freeboard is the height of the top of the tank from the water surface (=the top edge of the weir).

Air requirement for mixing	= 2 x 29 = 58 m <sup>3</sup> /Hr	This requirement is @ 2 m <sup>3</sup> /hr / m <sup>2</sup> floor area
Air to be supplied	<b>95 m<sup>3</sup>/hr</b>	The highest quantity of the three iterations above. (In this case, the volume-based requirement is the highest, so that figure overrides the others.)
Select size of diffusers	90 OD <sup>30</sup> x 1000 Length	Selected to suit the geometry of the tank, and to minimize the number of diffusers used for the same quality of air dispensed.
No. of diffusers	= 95 / 8 = 11.8 Nos = 12 Nos (nearest whole number)	= (Air to be supplied) / (minimum air flux rating)  The data sheets for the diffusers show a desirable range of air flux rate of 8 – 12 m <sup>3</sup> /Hr. (The diffuser will work properly only if compressed air is supplied in excess of this rate.)
Placement of diffusers	12 diffusers (6 pairs) are arranged in a row, set apart by 8 / 6 = 1.3 m	Rows are distributed evenly along the length of the tank.
Diffuser configuration	Each pair is separate, with its own air hose, nylon tie rope and ballast.	We should be able to easily retrieve each pair of diffusers from sewage. If all diffusers are interconnected as a single array, it would be too heavy for a single person to lift. It would also make it difficult to isolate a faulty diffuser.

**Tip:**

The tank volume can be linearly extrapolated based on design quantity of sewage.

## Clarifier Tank

The design of the clarifier tank caters to two separate flow paths:

1. The flow of clarified sewage that flows over the weir (the top edge of the launder)

This decanted sewage is taken to the filters.

2. The flow of solids that settle toward the bottom of the tank.

This bacterial mass is taken back to the aeration tank.

The first is called “hydraulic” and the second is called “solid”.

**Note:**

The hydraulic design criteria for a clarifier/ secondary settling tank are developed based on throughput flow only: The recycle sludge flow is not counted.

<sup>30</sup> OD = Outer Diameter

Parameter	Value/Calculation	Remarks
Design throughput flow	120 m <sup>3</sup> /day	Quantity of sewage to be handled by the STP on daily basis (ref. page 82)
Max. hourly throughput	= 120 m <sup>3</sup> / 20 hours = 6 m <sup>3</sup> /Hr	Assuming 20 hours of pumping in small plants. The 4 hours of down time is a worst-case scenario: In practice, pumping will be done for more than 20 hours. Thus the actual hourly throughput rate will be always less than this.
Design overflow rate	16 m <sup>3</sup> /m <sup>2</sup> /day = 0.67 m <sup>3</sup> /m <sup>2</sup> /Hr	This is a proven figure for extended aeration biological processes.
Cross-sectional area of tank	= 6 / 0.67 m <sup>2</sup> = 9 m <sup>2</sup>	= (Hourly throughput) / (hourly loading rate)
Dimensions	For a square tank- = 3 x 3 m	Area of a square = Side <sup>2</sup>
	For a circular tank- = 3.4 m Dia	Area of a circle = π/4 x Dia <sup>2</sup>
Depth of tank	2.5 m to 3.0 m	Selected by convention
Solids load	= 6 m <sup>3</sup> /hr x 3.5 kg/ m <sup>3</sup> = 21 kg/Hr	= Hourly throughput x MLSS  This is the volume of bacteria that gets added to the tank. MLSS value of 3.5 kg/m <sup>3</sup> is taken from the Design Criteria table (see page 81).
Solids loading rate	= 21 / 9 = 2.33 kg/m <sup>2</sup> /Hr	= (Solids load) / (Cross-sectional area of tank)  The calculated value is within the limit of 3.0. <sup>31</sup>
Weir length in clarifier	= 2 x 3 for a square tank = 6 RM	Length of launder = 2 x Side  For a square tank with launder on two sides,
	= 3.14 x 3.4 for a circular tank = 10 RM	Length of launder = π x Dia  For a circular tank with launder around the periphery
Weir loading rate	= 120/6 = 20 m <sup>3</sup> /RM/day	The calculated value is within the limit of 50. <sup>32</sup>  = (Sewage flow rate) / (length of weir)  For square tank, the weir is 6 RM long.
	= 120/10	= (Sewage flow rate) / (length of weir)
	= 12 m <sup>3</sup> /RM/day	For circular tank, the weir is 10 RM long.

<sup>31</sup> Only in thickener tanks, if the solids loading rate exceeds 3.0, then the area of the thickener will have to be increased.

<sup>32</sup> Only in very large clarifiers, the loading rate may exceed 50, in which case additional launders are provided. In fact, the cross-sectional area of the clarifier can be linearly extrapolated based on the design quantity of sewage

Volume of tank	= $9 \times 2.5$ = $22.5 \text{ m}^3$	Volume = Area x depth
Hydraulic detention time <sup>33</sup>	= $22.5 / 120 \times 24$ = 4.5 Hrs	= (Tank Volume) / (throughput rate) x 24 hours Compared to ideal range of 2.5 – 3 hours, this result is slightly on high side. This cannot be avoided in small plants due to minimum depth requirement

## Airlift Pump

The airlift pump returns the active sludge to the aeration pump.

The airlift pumps require 5-10 m<sup>3</sup>/Hr to work.

- The air-flow is adjusted till we achieve the exact sludge flow rate

## Electric Pumps for Return Sludge

These pumps are a less-preferred alternative to airlift pumps (see above). However, if the prevailing conditions do not allow use of airlift pumps, or if the designer opts for this design option, these pumps are necessary.

The design requirements for these pumps are same as those for the raw sewage lift pumps. Therefore the same pump models can be selected for the return sludge application as well.

Therefore, refer to the raw sludge lift pump section (see page 85).

## Sludge-holding sump

This tank is needed if the designer does not prefer the airlift pumps or the direct-suction sludge-return methods.

The following calculations show the tank capacity and the aeration requirements for this tank.

Parameter	Value/Calculation	Remarks
Design throughput flow	120 m <sup>3</sup> /day	Quantity of sewage to be handled by the STP on daily basis (ref. page 82)
Maximum rate of sludge-recirculation	100 % of throughput sewage flow	Typically Recirculation rate varies from 60 – 100 % of throughput flow to maintain desired MLSS levels. Therefore the pump must be capable of handling the highest flow rate (=sewage throughput rate).

<sup>33</sup> Note that the detention time for solids (bacterial flocs) is a separate parameter, which has a typical value of only 1 hour (if bacteria are detained for longer, they will start dying).

Sludge slump capacity	= $120 / 24 \times 0.5$ = $2.5 \text{ m}^3$ (Minimum)	The sump should be capable of buffering the return flow for 30 minutes.
-----------------------	--	---

## Pressure Sand Filter

The filter should be able to treat all the water that is decanted from the Secondary Clarifier tank.

The following calculations show the filter capacity required for our STP.

Parameter	Value/Calculation	Remarks
Design throughput flow	120 m <sup>3</sup> /day	Quantity of sewage to be handled by the STP on daily basis (ref. page 82)
Design filtration hours	20 Hrs (per day)	Allow 4 hours for rest, backwash, etc.
Filtration rate	= $120 / 20$ = $6 \text{ m}^3/\text{Hr}$	The filter must be able to handle the clarified water at this rate.
Loading rate on filter	$12 \text{ m}^3/\text{m}^2 / \text{Hr}$	Empirically taken optimum value, to achieve filtration efficiency at minimum size of filter
Filter cross-sectional area required (min)	= $6 / 12$ = $0.5 \text{ m}^2$	= (Filtration rate) / (Loading rate)
Diameter of filter (min)	= $(0.5 \times 4 / \pi)^{1/2}$ = $0.8 \text{ m}$	Area of a circle = $\pi/4 \times \text{Dia}^2$
Height of filter	1.5 – 1.8 m	Selected by convention
Depth of sand layer	0.6 – 0.75 m	Selected by convention

### Tip:

Cross-sectional area of the filter can be linearly extrapolated based on design quantity of sewage

## Activated Carbon Filter

The filter should be able to treat all the water that is filtered by the sand filter.

The following calculations show the filter capacity required for our STP.

Parameter	Value/Calculation	Remarks
Design throughput flow	120 m <sup>3</sup> /day	Quantity of sewage to be handled by the STP on daily basis (ref. page 82)
Design filtration hours	20 Hrs (per day)	Allow 4 hours for rest, backwash, etc.
Filtration rate	= 120 / 20 = 6 m <sup>3</sup> /Hr	= (water quantity to be filtered) / (operation hours)
Loading rate on filter <sup>34</sup>	10 m <sup>3</sup> /m <sup>2</sup> / Hr	Empirically taken optimum value, to achieve filtration efficiency at minimum size of filter.
Filter cross-sectional area required (min)	= 6 / 10 = 0.6 m <sup>2</sup>	Filter cross-sectional area = (Flow rate) / (loading rate)
Diameter of filter (min)	= (0.6 x 4/ π) <sup>1/2</sup> = 0.9 m	Area of a circle= π/4 x Dia <sup>2</sup>
Height of filter	1.5 – 1.8 m	Selected by convention
Depth of carbon layer	0.6 – 0.75 m	Selected by convention

**Tip:**

The cross-sectional area of the filter can be linearly extrapolated based on design quantity of sewage

34 Notice that the loading rate for ACF is smaller than the loading rate for PSF. As a result, the ACF has a marginally larger diameter.

## Sodium Hypo Dosing System

The filtered water has to be disinfected before it can be used for flushing, gardening, etc..

The following calculations show the required capacity of this disinfection system.

Parameter	Value/Calculation	Remarks
Design throughput flow	120 m <sup>3</sup> /day	Quantity of sewage to be handled by the STP on daily basis (ref. page 82)
Design Max. Chlorine dose	5 PPM = 5 mg/L = 0.005 kg/m <sup>3</sup>	PPM = Parts per Million = mg/L 1 kg = 10 <sup>6</sup> mg, 1 m <sup>3</sup> = 1000 L.
Chlorine dose per day	= 120 x 0.005 = 0.6 kg	
Hypo dose per day	= 0.6 / 0.1 = 6 kg/day	Hypo is available at 10 % strength.
Select Hypo tank capacity	50 L	Mix 6 kg Hypo in 44 L of water (Approx. 6 L + 44 L = 50 L)
Dosing pump rating <sup>35</sup>	0-4 L/Hr	This rate is adequate to dispense 50 L of Hypo in 20 hours

**Note:**

Controls must ensure that the chlorine pump is run only when the filters are in operation.

35 The dosing pump is adjustable. Therefore its rating should be chosen such that our required value lies between 50-75% of its maximum rated flow rate.



# Sludge Dewatering System

Wet sludge coming out of the bottom of the clarifier is in slurry form. This slurry is dewatered to create “cakes” (small bricks).

The following calculations show what kind of filter press would be needed for our STP.

Parameter	Value/Calculation	Remarks
Design throughput flow	120 KLD	Quantity of sewage to be handled by the STP on daily basis (ref. page 82)
Design BOD removal	30 kg/day	= 120 KLD x 250 mg/L = 120000 L/day x 0.000250 kg/L = 30 kg/day
Excess Sludge produced	= 30 x 0.25 = 7.5 kg/day	Dry weight basis, 0.25 kg of excess sludge per kg of BOD)
Slurry consistency <sup>36</sup>	0.8 – 1.0 %	Typical thickening achieved in a clarifier with 2.5 – 3.0 water depth.
Slurry volume	= 7.5 / 0.8 x 100 = 950 L	In words, the 7.5 kg of excess sludge is contained in 750 L of liquid mix that settles at the bottom of the clarifier tank.  <b>Note:</b> <i>That this volume of excess sludge builds gradually over a 24-hour period: It does NOT mean that at any given moment this quantity is present at the bottom of the clarifier tank, waiting to be pumped off. The sludge would have to be pumped out as it builds.</i>
Filter press operation	1 batch per day. Each batch takes 4 Hrs	A free choice by the designer.
Filter press feed pump	0.5 m <sup>3</sup> /Hr at 5 kg delivery pressure	Capable of delivering up to 2 m <sup>3</sup> in 4 hours of operation, which is adequate
Proportion of solids in the cake	= 25 % =0.25 (as a fraction)	Sludge cake has 75% moisture.
Sludge cake volume	=7.5 / 0.25 = 30 L	= (Excess sludge produced) / (Proportion of solids).

<sup>36</sup> In other words, at the bottom of the clarifier tank, the density of the sludge is 0.8 to 1.0% (by weight). The remaining 99 to 99.2% (by weight) content is water. Thus even a 3 m deep tank does not achieve solid dense sediment at all.

Cake-holding capacity of the filter press	30 L	This is the minimum required capacity: Select a press with larger capacity. (You can always remove some plates if the quantity of sludge is less.)
Select filter press size	470 x 470	Standard plate size, easy to handle in small plants
Cake thickness in chamber	20-25 mm	This is the practically achievable cake thickness, after which the filtration rate drops dramatically.
Volume of each chamber	= 0.42 x 0.42 x 0.02 = 3.5 L	Figures taken from the catalog of the filter press. (The plate edges do not contribute to chamber volume)
Required No. of chambers	10	To give 35 L total cake-holding capacity (a little above the minimum requirement)

**Tip:**

*The number of plates in the filter press can be linearly extrapolated.*

# Engineering checks for the STP

The following tables show how to check for important engineering aspects of the STP. Each table describes checks for a particular stage of STP.

The methods of checking are as follows:

Code	Method	How to check-
V	Visual	Check for presence (or absence) of the indicated feature <b>Note:</b> Olfactory checks are also clubbed with visual checks
M	Measurement	Measure the indicated dimensions and compare against specified limits.
T	Performance test	Conduct a test and compare the results against the specified limits.
D	Documentation check	Check in drawings and calculations <i>(typically for aspects that cannot be checked by visual inspection or other testing methods)</i>

**Note:** Some of the units have alternative designs. For example, the clarifier tank may be either hopper-bottom (purely gravity-aided) or mechanized (with rotating rake). Separate tables are provided for each alternative design. Please select the correct table.

## Preparation

Sl.	Item	Check	Acceptance Criteria	Method	Category	Rationale
1	Design verification	Verify against the design	<ul style="list-style-type: none"> <li>All dimensions must be as per design (See the solved example for step-by-step calculation)</li> <li>All deviations must be reviewed and approved</li> </ul>	M	Mandatory	Before scanning the STP for engineering aspects, the entire process-chain must be verified against the design, so that we do not end up wasting energy only to realize that it is inadequate in the first place.

2	DG backup	Sufficient DG backup	Minimum required backup power = Combined power for all units +20% margin. <ul style="list-style-type: none"> <li>For a duplicated pair of pumps, count only one pump as load.</li> </ul>	M	Mandatory	This is a continuous process. If aeration breaks down for over an hour, all bacteria may die. If pumping stops, the tanks may overflow. Thus uninterrupted power is essential.
---	-----------	----------------------	--	---	-----------	--

## Bar Screen

Sl.	Check	Acceptance Criteria	Method	Category	Rationale
1	Chamber location	The manhole (or the opening from where the debris is removed) must not lie in a public area.	V	Mandatory	Must allow safe and hygienic way of collecting and disposing off the debris. The debris removed from the STP is coated with sewage. It must not soil public areas.
2	Accessibility	The top of the screen must not be more than two feet below the operating floor level. <ul style="list-style-type: none"> <li>Best efficiency can be achieved if waist-level access is provided to the chamber.</li> </ul>	V	Mandatory	If access is not easy, the chamber will not be cleaned as frequently as needed.
3	Screen inclination	The screen must be inclined (Recommended inclination: 45° to 60°)	V	Mandatory	The bar screen has to be cleaned several times in a day. Therefore this operation must not be difficult and tiring. An inclined screen is far easier to clean. This prevents operator fatigue.  On the other hand, vertical screens are difficult to clean.



4	Robustness of bars	Bars are robust to withstand abuse and corrosion. (Typically, MS flats of 20x5 mm are to be used)	M	Recommended	The operator may use heavy-handed methods to remove the trapped debris. The bars must be robust enough not to bend (-and allow enlarged gaps-) under such abuse. Further, the bars must withstand moderate corrosion with passing time without weakening.
5	Coarse screen used	<ul style="list-style-type: none"> <li>Coarse screen (with 15 mm opening) fixed.</li> <li>The screen is inclined at 40° to 60°.</li> <li>The coarse screen is fixed BEFORE the fine screen.</li> </ul> <p><b>Note: Mandatory for large STPs (&gt;500 KLD) only.</b></p>	M	Mandatory	This screen traps larger items and reduces the load on the fine screen.
6	Platform	<ul style="list-style-type: none"> <li>Minimum width= 2 ft</li> <li>Must carry 120 kg weight without sagging</li> <li>Must be rust-proof (e.g. made of RCC)</li> </ul>	V	Mandatory	<p>The operator must be able to work safely without falling off the platform by accident. The platform must be able to carry the operator's weight.</p> <p>It must be able to hold the screened debris for drip-drying. The construction must be corrosion-proof so that it does not weaken with time.</p>
7	Hand-rake for operator	Rake must be capable of picking trapped debris from the screen, and also picking up debris from any corner of the floor.	T	Mandatory	If the rake cannot remove the debris from the floor and grill, it will remain in the chamber and block the flow.
8	Epoxy coating	The bars should be painted with epoxy-coat. (Not required for Stainless Steel bars)	V	Recommended	For longer life of the grill
9	Stainless Steel bars	<ul style="list-style-type: none"> <li>Bars are made of Stainless Steel.</li> </ul>	V	Optional	For longer life of the grill

## Equalization tank

Sl.	Check	Acceptance Criteria	Method	Category	Rationale
1	Easily accessible	The tank must be easily accessible.	V	Mandatory	For periodic cleaning with safety and comfort for a gang of cleaners to carry out the task
2	Safe entry	<p>The following features must be present, at minimum:</p> <ul style="list-style-type: none"> <li>Ventilation to dispel the gases/ odor</li> <li>Good lighting that reaches inside the tank</li> <li>Platform that allows easy reach inside the tank</li> </ul>	V	Mandatory	<p>The operator has to access the inside of the tank for periodic cleaning and to maintain the diffusers.</p> <p>The tank has relatively low oxygen level and the raw sewage emits hazardous gases and strong odor. So the operator must be provided with safety equipments such as mask, gloves, full body harness, gum boots.</p>
3	Aeration and mixing	<ul style="list-style-type: none"> <li>Diffusers in sufficient number to cover the entire floor</li> <li>Uniform placement of diffusers</li> <li>The aeration is uniform across the surface.</li> </ul> <p>(Test practically with a dummy load.)</p>	V, T	Mandatory	To prevent the solids from settling in dead zones (which in turn avoids the necessity to clean the tank frequently)
4	Diffuser type	<ul style="list-style-type: none"> <li>Coarse bubble diffusers are used (not fine-bubble diffusers)</li> </ul>	V	Mandatory	Unlike the fine bubble diffusers, the coarse bubble diffusers are not affected by fluctuating water level
5	Floor slope towards suction pit for pumps	Floor slope towards suction pit for pumps	V	Mandatory	<p>For complete evacuation of contents by pump.</p> <p>Floor slope is given so that during tank cleaning, all the water is collected in the suction pit of the pumps and the equalization tank is evacuated by pumps alone, with minimum manual cleaning required.</p>



6	Openness of tank	The tank must be open to the extent of being able to disperse the gases, access all the diffusers placed in the tank, and for safe entry of operators during cleaning operations.	V	Recommended	To prevent accumulation of gases, easy access to diffusers for maintenance purposes, and safe and secure entry for periodic cleaning
7	Diffusers in retrievable execution	The PCC ballast block holding down the diffusers must be provided with a Nylon rope which extends to the top of the tank and tied to a convenient post.	V	Recommended	For periodic maintenance of membranes without shutting down the aeration tank

## Raw Sewage Lift Pumps

Sl.	Check	Acceptance Criteria	Method	Category	Rationale
1	Pump rating	The pump must have around 110% of the STP flow rate (reference: page 81).			Since pumps are available with a few discrete operating points (head vs volume), it is difficult to get a pump that exactly meets the requirement. Thus it is necessary to select a pump that rated only a little higher than the ideal. Too high a rating would waste energy. Too little a rating would mean the STP would not be able to handle the daily volumes.
2	Redundancy	<ul style="list-style-type: none"> <li>Both pumps must be of same rating.</li> <li>Control circuits must prevent both pumps from running simultaneously</li> </ul>	V	Mandatory	This is a critical unit; so it must have a standby to avoid stoppage of the pumping.
3	Easily accessible	Minimum clearance of 1 ft on all sides	V	Mandatory	Space must be available for regular maintenance, since these pumps are prone to frequent choking.

4	Proper suction piping	<ul style="list-style-type: none"> <li>The pipe size must match with the pump's suction port or one size higher only.</li> <li>The suction pipes must NOT be fitted with foot valves</li> </ul>	V	Mandatory	<ol style="list-style-type: none"> <li>Mismatching pipes would lower the efficiency of the pumps.</li> <li>Foot valves get choked frequently; therefore must be avoided.</li> </ol>
		Separate suction pipes are provided for each pump	V	Recommended	If a single pipe is provided, the operator has to shut off both pumps to clean it.
5	Proper delivery header	<ul style="list-style-type: none"> <li>Control valves are provided in the outlet to shut off any branch (for pump repair, etc.)</li> <li>Elbows are used for corners instead of tee-joints, necessary fittings such as unions/ flanges are provided for easy dismantling and maintenance of the piping system, etc.</li> </ul>	V	Mandatory	In order to maintain pump efficiency
6	Bypass pipeline	<ul style="list-style-type: none"> <li>The pipeline must be terminated above the highest sewage level;</li> <li>The delivery end must be easily observable by the operator at all times without lifting any manhole covers, etc.</li> </ul>	V	Mandatory	To maintain the rate of sewage flow (to the aeration tank) at the desired value.
7	Pump type	Centrifugal, solids handling, non clog pumps instead of submersible pumps	V	Recommended	The SH-NC type pump has several inherent advantages (Ref: page 37.)

## Aeration tank

Sl.	Check	Acceptance Criteria	Method	Category	Rationale
1	Head room	<ul style="list-style-type: none"> <li>Minimum headroom = 3 ft</li> <li>Not obstructed by pipes, or ventilation ducts etc.</li> </ul>	V,M	Mandatory	Required to let the gases escape and also for regular maintenance/cleaning of diffusers
2	Work-platform	<ul style="list-style-type: none"> <li>Must provide waist-level access to tank</li> <li>Must have safety railings,</li> <li>Minimum width=3 ft</li> <li>Must have anti-skid surface</li> <li>If made from MS, must be painted to prevent corrosion</li> </ul>	V	Mandatory	Required for MLSS check, and maintenance of the diffusers
3	Shape of tank	<ul style="list-style-type: none"> <li>The shape of the tank must not obstruct placement of diffusers.</li> <li>Test the uniformity and full coverage of bubbles with a dummy load.</li> </ul>	V,T	Mandatory	The shape of tank must allow uniform aeration, and also thorough mixing of sewage and sludge for vigorous and healthy growth of bacteria.
4	Inlet pipe	Elbow/T joint at the end to deliver the sewage downward;	V	Mandatory	The pipe must not propel the sewage toward the outlet.
5	Inlet pipe placement	The raw sewage and sludge inlet pipes are above the sewage level (i.e., above the weir of the outlet-side launder)	V	Mandatory	Discharge of both raw sewage and sludge into aeration tank should be visible for monitoring purposes, and not immersed inside water.

6	Baffle wall	A baffle wall is provided	V	Recommended (Mandatory in STPs below 50 KLD)	To prevent short-circuiting of sewage: The incoming sewage must not head straight toward the exit without adequate retention (digestion) in the tank.
		The height of the baffle wall above the water surface must be equal to the other walls of the tank	V	Mandatory	To ensure that the incoming sludge does not “boil” over the baffle wall (no overflow).
		The depth of the baffle wall under the water surface must be between 0.25D and 0.30D. <ul style="list-style-type: none"> <li>Where D = Depth of water in the tank.</li> </ul>	V	Mandatory	To prevent possibility of creating a dead zone immediately behind the baffle wall.
7	RAS inlet and sewage inlet pipe placement	Maximum distance between the sewage inlet pipe and return sludge inlet pipe= 2 ft.	V	Mandatory	Recirculated sludge must be delivered in close vicinity of the raw sewage inlet, to ensure maximum, intimate contact between sewage and bacteria.
8	Inlet-outlet separation	The inlet is positioned to give maximum possible linear distance from the outlet	V	Mandatory	The inlet and outlet must be placed farthest from each other; to ensure maximum possible retention time of sewage (and thus treatment) in the tank.
9	Launder for outlet	It is easy to reach the mesh on the outlet port, for cleaning purposes.	V	Mandatory	If the mesh is not cleaned regularly, it would lead to blocking of outlet, and overflow of the tank.
10	Freeboard	The freeboard must be 0.3 to 0.5 m.	M	Mandatory	To prevent emergency situations. A recommended practice should be level-monitoring and warning system (float switch in the tank connected to an alarm annunciator).
11	Air hose	The hose must be rated for high temperatures.	V	Mandatory	To be able to handle the compressed air, which becomes hot. This avoids softening of the hose and rupture.

12	Retrievability of diffusers	<p>Check for maintenance features:</p> <ul style="list-style-type: none"> <li>The headroom and horizontal clearance between pillars must be adequate to allow easy removal of the diffuser assemblies.</li> <li>Nylon rope must be of sufficient size to lift the diffuser assembly</li> </ul>	V	Mandatory	<p>To avoid messy shut down of aeration tank.</p> <p>Add checks for structural features that allow this.</p>
13	Air-control valves	Each set of diffusers must have individual air control valve	V	Mandatory	Required for pulling out of individual sets of diffusers for maintenance.
14	Membrane type diffuser	Makeshift diffusers, such as PVC/ HDPE pipe with drilled holes or Coarse bubble diffusers must not be used.	V	Mandatory	The aeration tanks need to transfer oxygen to sewage with high efficiency. Only fine bubble diffusers are suitable for this purpose.
15	Number of compartments	Tank is divided in two compartments, each with diffusers.	V	Optional Mandatory for STPs > 500 KLD	Enables temporary shut down of one aeration tank while the other tank continues to work.

## Secondary settling tank (Hopper-bottom)

**Note:** Select this table if the settling tank is non-mechanized. Select the next table if the STP uses a mechanized clarifier tank.

Sl.	Check	Acceptance Criteria	Method	Category	Rationale
1	Inlet pipe size	<ul style="list-style-type: none"> <li>The inlet pipe from aeration tank to clarifier must be large enough to handle recirculation flow also</li> </ul>	M	Mandatory	The inlet pipe handles almost double the average hourly flow of the STP, because of almost equal amount of sludge that is recirculated.

2	Feed well (Influent well)	<ul style="list-style-type: none"> <li>Inlet to the clarifier must be through a feed well</li> <li>The feed well is of sufficient size typically 300 dia in small tanks to 800 mm Dia in larger tanks</li> <li>The well is located at the center of the tank</li> <li>An inlet baffle wall can be used in place of a feedwell, but <b>only if</b> there is a single launder at the opposite side (i.e., the outlet end) of the settling tank.</li> </ul>	V	Mandatory	To kill kinetic energy of the incoming flow and present calm conditions for settling, and prevent short circuiting
3	Inlet flow direction	Inlet flow must not drop down vertically into the feed well, but must enter radially.	V	Mandatory	Vertical flow will transfer kinetic energy downwards, disturbing bacteria that has already settled.
4	Overflow weir	<ul style="list-style-type: none"> <li>Weir is provided all round in case of a circular tank.</li> <li>Weir is provided on at least two sides in case of square tanks up to 200 KLD</li> <li>Weir is provided on all four sides in case of square tanks above 200 KLD</li> </ul>	V	Mandatory	The longest-possible weir should be provided to reduce the localized high upflow velocities that can pull up the solids from the depth of the tank.
5	Weir level	The weir is at a uniform level all round (check with tube level gauge)	T	Mandatory	If weir is uneven, the overflow will occur only in some sections of the weir, resulting in high localized upflow velocities; which in turn will pull up the flocs, overloading the filters that follow
6	Total water depth	The water depth at the center of the tank must be 2.5 m or more.	M	Mandatory	To achieve sufficient clarification in the supernatant overflow and thickening of solids in the underflow



7	Depth of central sludge hopper	The depth of hopper at the center must be 200 mm or more.	M	Mandatory	To provide for the minimum 100 mm dia sludge withdrawal pipe
8	Straight depth	Minimum straight depth must be 1.2 m	M	Mandatory	To achieve sufficient clarification in supernatant water and thickening of sludge in the underflow
9	Hopper slope	Sloping hopper must have minimum 45° slope	M	Mandatory	To enable rolling down of settled sludge on the sloping walls to a central pit.
10	Dia of sludge pipe	If sludge pipe is buried beneath the tank floor, its dia must be 100 (nominal) or more. This minimum Diameter ensures that smaller articles do not choke the pipe frequently.	V	Mandatory	To prevent clogging of buried pipe
11	Bottom pit	The square bottom floor pit must not be more than 300x300mm	V	Mandatory	If the pit is too large, the suction pipe cannot remove the bacteria settled at the periphery of the pit.
12	Air lift pump	Air lift sludge recirculation suction-head must be placed about 0.5 m from bottom of tank	V	Mandatory	If the suction-head is placed too high/low, the pipe will not be able to collect all the bacteria settled at bottom.

## Secondary Clarifier tank (mechanized, with Rotating Rake)

**Note:** Select this table if the STP uses a mechanized clarifier tank. If the settling tank is non-mechanized, select the previous table.

Sl.	Check	Acceptance Criteria	Method	Category	Rationale
1	Provision of rake	Rotating rake with a set of squeegees is provided	V	Recommended for STPs between 150-200 KLD. Mandatory for STPs above 200 KLD.	In larger tanks, the sludge does not move to the center by gravity. Raking of the settled sludge is needed to push the sludge to a central sludge-collection pit.

2	Drive mechanism support bridge	Bridge is required to mount the motor, gearbox at the centre of the tank, and also for maintenance purposes	V	Mandatory	Required to support the motor and gear box.
3	Handrail on bridge	<ul style="list-style-type: none"> <li>Hand-rails cover entire length of the bridge.</li> <li>Hand-rails are of adequate height.</li> </ul>	V	Mandatory	The clarifier is a large tank, with moving parts and possibly wet area. Thus the rails are essential to prevent the operator from falling in.
4	Mechanism located in exact center of tank	<ul style="list-style-type: none"> <li>The shaft of the rake mechanism must be located in exact center of the clarifier tank.</li> <li>The tank must be perfect square/perfect circle (not oblong)</li> <li>The rake blades must reach close to walls of the tank</li> </ul>	V,M,T	Mandatory	If any area of the floor remains unswept, the flocs will not be collected and returned to the aeration tank.
5	Rubber blades	<ul style="list-style-type: none"> <li>Rake blades must be provided with bottom wearable rubber squeegees to sweep the tank floor</li> </ul>	V	Mandatory	To prevent bacteria from remaining on the floor of the tank
6	Blade overlap	<ul style="list-style-type: none"> <li>In a double-winged rake, blades on opposite arms of the mechanism must overlap</li> <li>In a single-winged rake, all the blades must overlap within the single set.</li> </ul>	V,M	Mandatory	To ensure that all the settled bacterial mass is swept to the central collection pit in minimum time
7	Rotational speed	Rotational speed of the mechanism must be 4 to 6 rounds per hour.	T	Mandatory	If the rake rotates at higher speeds, its wake will disturb the settled bacteria; and at lower speeds, the bacteria will remain for too long a period on the floor, and start dying due to lack of oxygen and food.

8	Uniform floor slope	<ul style="list-style-type: none"> <li>The tank floor must have uniform slope.</li> <li>The surface must not be uneven (no pits, depressed areas or bumps).</li> <li>The surface must not be rough (it will damage OR wear out the rubber squeegees)</li> </ul>	V,T	Mandatory	To prevent pockets of stationary sludge on the floor.
9	Slope of corners in a square tank	In square tanks, the four corners that are not swept by the blades must have steep 45° slope	V,M	Mandatory	The four corners of a square are not swept by the rotating blades; so they will accumulate sludge, which will die and putrefy.
10	Inlet pipe size	The inlet pipe from aeration tank to clarifier must be large enough to handle recirculation flow also	M	Mandatory	The inlet pipe handles almost double the average hourly flow of the STP, because of almost equal amount of sludge that is recirculated.
11	Feed well (Influent well)	<ul style="list-style-type: none"> <li>Inlet to the clarifier must be through a feed well</li> <li>The feed well is of sufficient size typically 300 dia in small tanks to 800 mm Dia in larger tanks</li> <li>The well is located at the center of the tank</li> </ul>	V	Mandatory	To kill kinetic energy of the incoming flow and present calm conditions for settling, and prevent short circuiting
12	Inlet flow direction	Inlet flow must not drop down vertically into the feed well, but must enter radially	V	Mandatory	Vertical flow will transfer kinetic energy downwards, disturbing settled bacteria
13	Overflow weir	<ul style="list-style-type: none"> <li>Weir is provided all round in case of a circular tank.</li> <li>Weir is provided on at least two sides in case of square tanks up to 200 KLD</li> <li>Weir is provided on all four sides in case of square tanks above 200 KLD</li> </ul>	V	Mandatory	The longest-possible weir should be provided to reduce the localized high upflow velocities that can pull up the solids from the depth of the tank.

14	Weir level	The weir is at a uniform level all round (check with tube level gauge)	T	Mandatory	If weir is uneven, the overflow will occur only in some sections of the weir, resulting in high localized upflow velocities; which in turn will pull up the flocs, overloading the filters that follow
15	Floor slope	Floor slope between 1:8 and 1:10	M	Mandatory	A gentle slope helps in movement of sludge toward the central pit.
16	Water depth	The water depth at the periphery of the tank is 2.5 m or more.	M	Mandatory	To achieve sufficient clarification in the supernatant overflow and thickening of solids in the underflow
17	Depth of central sludge pit	The depth of pit at the center is 200 mm or more	M	Mandatory	To provide for the minimum 100 mm dia sludge withdrawal pipe
18	Dia of sludge pipe	If sludge pipe is buried beneath the tank floor, its dia must be 100 NB or more.	V	Mandatory	A buried pipe is very difficult to clean, So, a large pipe is used, to ensure that small articles don't choke the pipe frequently.
19	Circular clarifier tank	The clarifier tank is circular.	V	Recommended	Easier to maintain
20	Squeegees	The squeegees may be of hard rubber or Brass.	V	Recommended	The squeegees should be able to sweep the floor of the tank thoroughly, without wearing out fast.
21	Bottom steady Bush	A bottom steady bush supports the central rotary shaft of the rake.	V	Recommended	Without a support at bottom, the rake assembly will swing around. As a result, the blades cannot sweep the floor uniformly. They will also strike the floor violently and get damaged.
22	Blade for pit	A rake blade is provided inside the central sludge pit to sweep it in large tanks	V	Optional	To prevent solidification of thick sludge in the large pit



## Sludge Recirculation pumps - Airlift

**Notes:**

1. Use this table if the STP design uses an airlift pump.
2. Use the next table if the STP design uses electric pumps (either in direct-suction mode or with a buffer sump)

Sl.	Check	Acceptance Criteria	Method	Category	Rationale
1	Pump type	Use an air-lift pump	V	Recommended	There are multiple reasons for preferring an air-lift pump: It saves energy and space, allows the operator to vary the flow rate of sludge (to control the MLSS), without needing an extra buffer tank; clogs rarely (and much easier to clean).

## Sludge Recirculation pumps - Electric

**Notes:**

1. Use the previous table if the STP design uses an airlift pump.
2. Use this table if the STP design uses electric pumps (either in direct-suction mode or with a buffer sump)

Sl.	Check	Acceptance Criteria	Method	Category	Rationale
1	Pump type	Centrifugal, non clog, solids handling pumps	V	Mandatory	Ref: page 37
2	Standby	For electrical pumps only (for direct suction or buffer sump) <ul style="list-style-type: none"> <li>• Both pumps must be of same rate.</li> <li>• Control circuits must prevent both pumps from running simultaneously.</li> </ul>	V	Mandatory	This is a critical unit: Stoppage of recirculation for about an hour may kill all bacteria and also cause overflow of tank.

3	Bypass branch line	<ul style="list-style-type: none"> <li>• Must be terminated above the highest sludge level (not immersed in sewage);</li> <li>• Placed so that the operator can observe the flow at all times without lifting any manhole covers, etc..</li> </ul>	V	Mandatory	Bypass branch line back to sludge sump ( if provided) for flow control
4	Delivery header	Proper delivery header	V	Mandatory	In order to maintain pump efficiency
5	Accessibility	Easily accessible	V	Mandatory	For ease of maintenance

## Sludge Recirculation system - Direct suction

**Note:**

Use this table in conjunction with the **Sludge Recirculation pumps-Electric** table.

Sl.	Check	Acceptance Criteria	Method	Category	Rationale
1	Suction pipeline from clarifier tank	Proper suction piping	V	Mandatory	In order to maintain pump efficiency

## Sludge Recirculation system - With a buffer sump

**Note:**

Use this table in conjunction with the **Sludge Recirculation pumps-Electric** table.

Sl.	Check	Acceptance Criteria	Method	Category	Rationale
1	Sump size	30 - 60 minutes retention capacity, calculated based on the average hourly flow	M	Recommended	To provide for recirculation of sludge to Aeration tank Although this is an optional unit, it has the capability to kill the bacteria if it is not designed well.
2	Depth of the sump	Should be between 1.5-2.5 m	M	Recommended	To accommodate the Coarse Bubble diffusers



3	Diffusers type	Coarse Bubble diffusers must be used (not fine bubble diffusers)	V	Mandatory	This tank is small and shallow; where the fine bubble diffusers are not suitable. Since this tank has a flat bottom the sludge needs to be agitated. This can be achieved with coarse bubble diffuser
4	Diffuser coverage	<ul style="list-style-type: none"> <li>The diffusers must cover the entire floor of the tank</li> <li>Check bubbles across the floor area with dummy load.</li> </ul>	V,T	Mandatory	To ensure that there are no dead zones in the tank, where the bacteria stagnate and die because of lack of food.

## Clarified water tank

Sl.	Check	Acceptance Criteria	Method	Category	Rationale
1	Aeration	0.5 m <sup>3</sup> /hr of air per m <sup>3</sup> of tank volume	V	Mandatory	To prevent solids accumulation
2	Tank capacity	<ul style="list-style-type: none"> <li>Sufficient holding capacity to match filter sizes and hours of filtration</li> <li>2-3 hours of average hourly flow in large plants if the filters are run continuously over 24 hours</li> <li>8-10 hours if the filter operation is for only 16 hours in a day, as in smaller STPs</li> </ul>	M	Mandatory	To provide sufficient stock of water to cover the rest period of pumps and for backwash water requirement

## Filter feed Pumps

Sl.	Check	Acceptance Criteria	Method	Category	Rationale
1	Standby Pump	<ul style="list-style-type: none"> <li>Standby pump is provided</li> <li>Both pumps must be of same rating</li> <li>Control circuits must prevent both pumps from running simultaneously.</li> </ul>	V	Mandatory	The filter is a critical unit

2	Pump type	Centrifugal, non clog, solids handling pumps OR	V	Mandatory	Choice available depending on soundness of STP
3	Accessibility	Easily accessible for maintenance purposes	V	Mandatory	For ease of maintenance
4	Suction pipe	Proper suction piping	V	Mandatory	In order to maintain pump efficiency
5	Delivery header	Proper delivery header with pressure gauge	V	Mandatory	In order to maintain pump efficiency
6	Bypass line	Bypass branch line back to Clarified water tank for flow control with a control valve	V	Mandatory	To control the flow rate to filters
7	Backwash pipe	Separate set of suction piping for backwash from filtered water tank	V	Recommended	Backwash with filtered water is more efficient
8	Plumbing	Non-return valves as required if the same pumps take suction both from clarified water tank and filtered water tank	V	Mandatory	To prevent water from clarified water tank and filtered tank from mixing up
9	Backwash pumps	Separate backwash pumps	V	Optional	Allows better engineering. Allows full isolation of clarified and filtered water tank

## Backwash pumps

**Note:** This table is applicable only when the design uses a separate set of pumps for backwash (not by reversing the flow of the filter-feed pumps)

Sl.	Check	Acceptance Criteria	Method	Category	Rationale
1	Standby	<ul style="list-style-type: none"> <li>Standby pump is provided</li> <li>Both pumps must be of same rating.</li> <li>Control circuits must prevent both pumps from running simultaneously.</li> </ul>	V	Mandatory	If the single backwash pump fails, the plumbing will not allow reversing the flow using the filter feed pump. Thus the choked filter will become a bottleneck.
2	Interlock between pumps	Interlock between filter feed pump and backwash pump	T	Mandatory	To prevent a filter feed pump and a backwash pump operating at the same time.

## Pressure Sand Filter

Sl.	Check	Acceptance Criteria	Method	Category	Rationale
1	Pressure test	5 kg/cm <sup>2</sup> pressure test certificate	D	Mandatory	Safety requirement
2	Manhole	Big enough manhole on top dish OR Entire top dish is bolted to the tank (up to 800 dia)	V	Mandatory	Safety requirement, ease of maintenance
3	Pressure-relief valve	Pressure relief valve on top	V	Mandatory	Safety feature
4	Backwash pipeline	Separate backwash waste line The backwash waste must be piped to Equalization tank; not to any other tank.	V	Mandatory	To avoid sudden surge flows into aeration tank or settling tank, the pipeline must be connected only to the equalization tank.

5	Inlet distributor	Proper inlet distributor for uniform dispersal of incoming flow over the entire area of the filter – like a splash pad : A distributor gridwork of pipe may also be used	D	Mandatory	Uniform distribution, better filtration
6	Frontal piping	MS frontal piping	V	Mandatory	To carry out various filter operations, without frequent outages.  Normally pipelines in an STP are made of PVC.  However, the frontal piping is subject to frequent stresses and strains due to operation of valves, and hence it is prone to failure at joints.  Therefore MS pipeline is recommended here.
7	MPV (Multi-Port Valve)	Multi-port valve	V	Recommended ONLY for small filters, up to 500 mm dia.	MPV is convenient, and provides interlocking
8	Valves	Individual Butterfly control valves in place of plastic MPV	V	Recommended	In large filters, a plastic PMV is prone to damage.  Therefore separate valves must be used in place of MPV.
9	Valves	<ul style="list-style-type: none"> <li>Valves easily operable</li> <li>Located for easy access for the operator without stretching or bending</li> <li>Butterfly valves are preferable to ball valves, for quick open/ shut operations</li> </ul>	V	Mandatory	Operator comfort, ergonomics

10	Pressure gauges	Inlet and outlet pressure gauges	V	Mandatory	To monitor condition of filter. If the filter is choked, a lot of energy is wasted, and throughput is reduced drastically 0.5 kg/cm <sup>2</sup> pressure drop across a filter is an indication of choked filter and to commence backwash
11	Media	Proper media filling, with graded gravel/ pebbles and sand	D	Mandatory	If the successive layers of media are not filled with graded material (increasing diameter of particles), the layers will break up and the media will mix up; thus affecting the 3D-filtering, which is essentially provided by the sand layer (at the top) only.
12	Hand-hole	Hand-hole provided at the bottom of the tank for easy maintenance	V	Mandatory	To remove media from the bottom, avoiding manual entry into the filter vessel
13	Collection mechanism	Proper manifold and pipe grid as underdrain collector		Mandatory	If sewage passes through a narrow local channel, the entire cross-section of the sand media would not be efficiently used.
14	Backwash line routing	Backwash waste line to be diverted to equalization tank and not Aeration tank		Mandatory	To avoid sudden surge flows into aeration tank or settling tank, the pipeline must be connected only to the equalization tank.

## Activated Carbon filter

Sl.	Check	Acceptance Criteria	Method	Category	Rationale
1	Pressure test	5 kg/cm <sup>2</sup> pressure test certificate	D	Mandatory	Safety requirement
2	Manhole	Sufficiently large manhole on the top dish, OR Entire top dish is bolted to the tank (up to 800 Dia)	V	Mandatory	Safety requirement, ease of maintenance
3	Pressure-relief valve	Pressure relief valve on top	V	Mandatory	Safety feature

4	Backwash pipeline	Separate backwash waste line The backwash waste must be piped to Equalization tank; not to any other tank.	V	Mandatory	To avoid sudden surge flows into aeration tank or settling tank, the pipeline must be connected only to the equalization tank.
5	Inlet distributor	Proper inlet distributor for uniform dispersal of incoming flow over the entire area of the filter – like a splash pad : A distributor gridwork of pipe may also be used	D	Mandatory	Uniform distribution, better filtration
6	Frontal piping	MS frontal piping	V	Mandatory	To carry out various filter operations, without frequent outages. Normally pipelines in an STP are made of PVC. However, the frontal piping is subject to frequent stresses and strains due to operation of valves, and hence it is prone to failure at joints. Therefore MS pipeline is recommended here.
7	MPV (Multi-Port Valve)	Multi-port valve	V	Recommended	Plastic MPV prone to damage ONLY for small filters, up to 500 mm dia.
8	Valves	Individual Butterfly control valves in place of plastic MPV	V	Recommended	In large filters, a plastic PMV is prone to damage. Therefore separate valves must be used in place of MPV.

9	Valves	<ul style="list-style-type: none"> <li>Valves easily operable</li> <li>Located for easy access for the operator without stretching or bending</li> <li>Butterfly valves are preferable to ball valves, for quick open/shut operations</li> </ul>	V	Mandatory	Operator comfort, ergonomics
10	Pressure gauges	Inlet and outlet pressure gauges	V	Mandatory	To monitor condition of filter. If the filter is choked, a lot of energy is wasted, and throughput is reduced drastically 0.5 kg/cm <sup>2</sup> pressure drop across a filter is an indication of choked filter and to commence backwash
11	Media	Proper media filling, with graded gravel/ pebbles and sand	D	Mandatory	If the successive layers of media are not filled with graded material (increasing diameter of particles), the layers will break up and the media will mix up; thus affecting the 3D-filtering, which is essentially provided by the sand layer (at the top) only.
12	Hand-hole	Hand-hole provided at the bottom of the tank for easy maintenance	V	Mandatory	To remove media from the bottom, avoiding manual entry into the filter vessel
13	Collection mechanism	Proper manifold and pipe grid as underdrain collector	D	Mandatory	
14	Backwash line routing	Backwash waste line to be diverted to equalization tank and not Aeration tank	V	Mandatory	To avoid sudden surge flows into aeration tank or settling tank, the pipeline must be connected only to the equalization tank.
15	Epoxy coating	Epoxy coating on the inside of the vessel	Specs	Mandatory	Carbon is corrosive and abrasive

## Disinfection system

Sl.	Check	Acceptance Criteria	Method	Category	Rationale
1	Hypo dosing	Hypo dosing at the outlet of the Activated Carbon filter	V	Mandatory	For proper disinfection, and to meet PCB norms

## Sludge-Handling system

Sl.	Check	Acceptance Criteria	Method	Category	Rationale
1	Sludge-holding tank	As per CFE	M	Mandatory	To hold the day's excess sludge until dewatering operations start
2	Diffusers	Sufficient coarse bubble diffusers are used, calculated at the rate of 2 m <sup>3</sup> air/Hr/ m <sup>3</sup> of tank volume	V	Mandatory	To ensure adequate aeration and mixing in the sludge-holding tank, to prevent septicity in sludge, and to maintain dewaterability.
3	Supernatant drain pipe	Supernatant water is drawn off from the sludge-holding tank by tap offs at 2 or 3 levels, so that water is removed and only thicker sludge is left in the tank	V	Recommended	Ensures that only thick slurry is fed to the filter press, to reduce the volume of sludge to be dewatered, and enhance dewatering rate
4	Suction line	Positive suction for the helical filter feed pump	V	Mandatory	Dry run causes serious damage
5	Bypass branch line	Bypass branch line in pump discharge line to control flow to Filter press	V	Mandatory	<ul style="list-style-type: none"> <li>To control feed rate to filter press</li> <li>For varying sludge conditions, condition of cloth, condition of the pump itself, the operator may need to control the feed rate to the filter press.</li> </ul>



6	Mixer	Proper low speed (300 RPM) mechanized mixing arrangement for polymer solution tank  For a typical Medium size STP, a tank of 200 L should be sufficient	T	Mandatory	Polymer is viscous. Low speeds to prevent degradation of long chain polymer  Large tank is required since 0.1 to 0.5 % polymer solution is recommended due to extremely high viscosity
7	Closing device for press	Manual Hydraulic closing device for filter press	V	Mandatory	To close the plates together under high pressure, leaving no gaps between plates, thus avoiding leakages during the high-pressure filtration cycle
8	Closing device for press	Motorized hydraulic closing device recommended in STPs above 1000 KLD	V	Recommended	To save manual labor
9	Drain tray	Drain tray for filter press	V	Mandatory	To avoid spillages on floor
10	Air pipe (drier)	A compressed air pipeline with control valve is provided	V	Mandatory	To aid in faster dewatering
11	Sheet cover	sheet cover over filter press, if placed in the open	V	Mandatory	To prevent degradation of Filter cloth under direct sunlight

## Air Blowers

Sl.	Check	Acceptance Criteria	Method	Category	Rationale
1	Standby	<ul style="list-style-type: none"> <li>Standby blower is provided</li> <li>Both blowers must be of same rating.</li> <li>Control circuits must prevent both blowers from running simultaneously</li> </ul>	V	Mandatory	Critical unit: The blowers supply compressed air to all diffusers (coarse and fine) in the multiple tanks. They also run the air-lift pump. Thus if this unit fails, the entire STP would come to grinding halt.
2	Air header	<ul style="list-style-type: none"> <li>Large air header (like an air-receiver tank) is provided.</li> </ul>	V	Mandatory	Larger air header prevents overheating of air, and lessens the pipeline's resistance.  It also lessens the back-pressure on the blower; especially when a remote valve is opened/closed swiftly.

3	Noise attenuation	Check for the following: <ul style="list-style-type: none"> <li>Not mounted on a tank (tanks amplify the noise)</li> <li>Mounted with anti-vibration mountings</li> <li>Padding around pipes to reduce vibrations.</li> </ul>	V	Mandatory	Since this unit is the noisiest in the STP, noise-reduction measures are necessary. If noise is not suppressed, it can reach unacceptable levels
4	Air pipelines	Air piping of adequate size as per good engineering practice.  Maximum air velocity around 10-12 m/sec.	V, M	Mandatory	Selection of proper cross-sections prevents excessive heating, and back pressure on blowers (< 12 m/sec)
5	Air vent	Provide for an air vent line for emergencies, so that when some tanks are under maintenance, excess air is not passed on to other tanks	V	Mandatory	To relieve excess air and overloading of diffusers in other tanks
6	Noise-reduction	Proper acoustic enclosures	V	Recommended	The air blowers create very high noise, which can affect the working efficiency and even the health of the operator.  Therefore noise-attenuation is required.

# MISC

Sl.	Check	Acceptance Criteria	Method	Category	Rationale
1	Pressure Gauges	At air blower, filter press, filters inlet and outlet	V	Mandatory	To monitor pressure levels at these points
2	Piping system	Good engineering practice are followed	V	Mandatory	<ol style="list-style-type: none"> <li>1. Minimum bends</li> <li>2. Proper anchoring to wall/ floor</li> <li>3. Fittings such as flanges, unions at appropriate locations for easy opening of sections of pipelines</li> <li>4. All frequently opened joints have adequate clearance to allow fast opening.</li> </ol>
3	Electrical System	<ul style="list-style-type: none"> <li>• ELCB must be used (not MCB)</li> <li>• Use of power factor capacitor banks to balance the load</li> <li>• Use of Bus bar to distribute the load evenly</li> <li>• Use of interlocks to prevent use of working and standby pumps</li> </ul>	V	Mandatory	<p>To avoid frequent down time, safety etc.</p> <p>In general compliance with the National Electric Code is a must.</p>
4	Exhaust/ Ventilation System if in basement room	Fresh air fan with fresh air ducting for at least 12 air changes per hour	V	Mandatory	Operator comfort, prevents accumulation of gases
5	Exhaust/ Ventilation System if in basement room	<ul style="list-style-type: none"> <li>• Exhaust air fan with exhaust air ducting</li> <li>• The exhaust fan must have a slightly higher capacity than the Fresh air fan, to maintain a small negative air pressure inside the STP</li> </ul>	V	Mandatory	Operator comfort, prevents accumulation of gases, and fugitive emissions out of the STP room

6	Flooring of the STP	<p>The National Building Code is followed in general.</p> <p>Specifically, check the following:</p> <ul style="list-style-type: none"> <li>• Drain provided for all tanks.</li> <li>• Sump provided to catch any accidental spillage</li> <li>• Floor is anti-slippage type and free of obstacles such as pipelines</li> <li>• Floor is sloped toward the drainage sump</li> <li>• A pump is provided to empty the sump into equalization tank.</li> </ul>	V	Mandatory	<p>Compliance with a mandatory national standard.</p> <p>Good engineering practice</p>
7	Fire safety	The STP area must meet the requirements of National Building Code Part IV (Fire and life safety)	V	Mandatory	<p>Compliance with a mandatory national standard.</p> <p>Safety of operators and other service personnel</p>
8	Documentation	<ol style="list-style-type: none"> <li>1. Operating manual covers all units</li> <li>2. Maintenance manual covers all units</li> <li>3. The following charts are provided:               <ol style="list-style-type: none"> <li>3a. Flow chart</li> <li>3b. Layout drawing</li> <li>3c. Labeling of all tanks with capacities and Depth as safety warning</li> <li>3d. Standard Operating Procedure</li> </ol> </li> </ol>	V	Mandatory	For proper record-keeping
9	Lighting	Adequate illumination for operator comfort	V	Mandatory	Operator comfort, ease of maintenance activities



10	Ladders	Adequate, safe ladders to access tanks	V	Mandatory	Safety requirement - Otherwise operator may fall into tank Typical measures: 1. Ladders with safety railings 2. Anti skid, wide treads 3. Rungs are NOT safe (the operator has to use them frequently) 4. Slope of ladder should be less than 45° 5. Provide landings for long ladders 6. In general, follow the National Building Code.
11	Platform with hand-rail	Proper operating / observation platforms with safety hand-rail	V	Mandatory	Safety requirement
12	Water meter	Water meter at the outlet of ACF	V	Mandatory	KSPCB-mandated consent condition
13	Fresh water supply	Fresh water supply in STP for various activities like area cleaning, chemical solution preparation, Filter cloth washing etc.	V	Mandatory	For good housekeeping, chemicals solution preparation
14	Acoustic isolation	If STP is in close vicinity to residences, acoustic treatment to be provided for the STP room/doors and windows.	V	Mandatory	Noise attenuation This must happen regardless of vicinity to residences.
15	Seating Arrangement for operator	<ul style="list-style-type: none"> <li>• Sitting area provided for the operator</li> <li>• Shielded from the noise of machinery</li> <li>• Should provide a clear view of the entire plant</li> <li>• Provision to maintain logbook.</li> <li>• Well-lit and ventilated</li> <li>• Not too comfortable so as to allow dozing off</li> </ul>	V	Mandatory	Operator comfort

16	Labeling of units	All units (as listed above) are labeled clearly with permanent labels	V	Mandatory	Quick identification of all parts of the plant
17	Storage for consumables	<ul style="list-style-type: none"> <li>• Proper storage area for all consumables and spares</li> <li>• Away from sewage spillage to avoid rusting</li> <li>• Clearly labeled</li> </ul>	V	Mandatory	Systematic and safe storage



# Operational checks for the STP

The following tables show how to check for important operational aspects of the STP. Each table describes checks for a particular stage of STP.

The methods of checking are as follows:

Code	Method	How to check-
V	Visual	Check for presence (or absence) of the indicated feature (olfactory checks are clubbed here)
M	Measurement	Measure the indicated dimensions and compare against specified limits.
T	Performance test	Conduct a test and compare the results against the specified limits.
D	Documentation check	<i>Check in drawings and calculations</i> (typically for aspects that cannot be checked with visual inspection or other testing methods)

Note that some of the units have alternative designs. For example, the clarifier tank may be either hopper-bottom (gravity-operated) or mechanized (with a rotating rake). Similarly, the sludge-recirculation subsystem may use one of the three approaches: (a) an airlift pump, or (b) a direct-suction electric pump or (c) electric pump with a buffer sump.

Separate tables are provided for each alternative design. Please select the correct table first and then use them.

## Preparation

Sl.	Check	Acceptance Criteria	Method	Rationale
1	Engineering check results	<ul style="list-style-type: none"> <li>The Engineering checklist is fully filled</li> <li>Any deviations are reviewed and approved.</li> </ul>	D	<p>Unless the STP has successfully passed the Engineering checks, do not proceed.</p> <p>(Passing of Engineering checks means the design and engineering of the plant meet the acceptance criteria)</p>
2	Visual check	All stages are as inspected during PCFO (no tampering was done afterward)	V	<p>If the plant was modified in any way after passing at the engineering approval, review the reasons and the actual changes carried out in the STP.</p> <p>Repeat the relevant engineering checks and review the results.</p>

3	Load	The actual load has reached >80% of rated load. (Check the volume of the treated sewage for a day. If there is a weekly peak in sewage generation, select that day for ALL measurements.)	M	For the operational checks to be meaningful, the load must be at least 80% of the rated load.
---	------	---	---	---

## Bar Screen Chamber

Sl.	Check	Acceptance Criteria	Method	Rationale
1	Working on platform	<p>Observe the operator as he collects debris.</p> <ul style="list-style-type: none"> <li>Posture is normal during working</li> <li>Does not have to balance on platform</li> <li>Can see the whole chamber easily.</li> <li>Not facing any difficulty</li> <li>Can easily reach the grill and floor.</li> <li>No struggle to remove parts stuck in grill.</li> </ul>	T	If the debris-collection is not comfortable, it will stop in a few days; leading to a clogged and dysfunctional bar screen chamber.
2	Handling of debris	<p>Observe the operator as he disposes off debris.</p> <ul style="list-style-type: none"> <li>Operator can easily use the platform (or a basket) to let the debris drip-dry</li> <li>Operator can easily place the collected debris into a garbage bag</li> </ul>	T	Disposal of debris must be easy and hygienic.

## Equalization tank

Sl.	Check	Acceptance Criteria	Method	Rationale
1	Actual level fluctuations	Check for overflows – telltale coloration on side walls/ freeboard	M	To determine if equalization tank size is adequate to handle peak inflows

2	Aeration and mixing	Bubbles rise across the entire surface of the aeration tank (no dead zone in any area, especially edges and corners) <ul style="list-style-type: none"> <li>• There is no odor</li> <li>• There is no localized violent bubbling/ boiling</li> </ul>	V	This is the end-result of proper diffuser selection and placement; and also correct air-pressure.
3	Maintenance of diffusers	Select a few diffusers (typically the diffuser in the most remote corner) and execute a mock repair cycle. <ul style="list-style-type: none"> <li>• Easy to isolate from the rest of the system</li> <li>• Easy to retrieve the chosen element</li> <li>• Easy to dismantle the element without disturbing the other plumbing.</li> <li>• Easy to clean the element</li> <li>• Easy to lower it back at the exact spot</li> </ul>	T	The STP should allow easy maintenance of diffusers without significant interruption of its process.

## Raw Sewage Lift Pumps tank

Sl.	Check	Acceptance Criteria	Method	Rationale
1	Easily accessible	Simulate a repair cycle on the pump that is more difficult to access. <ul style="list-style-type: none"> <li>• Easy to isolate from the rest of the system</li> <li>• Easy to dismantle</li> <li>• The rest of the plumbing is not disturbed</li> <li>• Easy to carry it outside its area</li> <li>• Easy to place it back and assemble it</li> </ul>	V	The STP should allow easy maintenance of pumps without significant interruption of its process.

## Aeration tank

Sl.	Check	Acceptance Criteria	Method	Rationale
1	Baffle wall function	The sewage is let into the baffle zone – No splash or overflow There is no bubble-free “dead” zone adjacent to the baffle wall on the “tank”	V	These signs indicate wrong dimensions of the baffle wall.

2	Diffuser function	<ul style="list-style-type: none"> <li>• Bubbles rise uniformly across the surface</li> <li>• No dead zone (especially near walls and corners)</li> <li>• No large bubbles bursting through.</li> </ul>	V	To get optimum results, you may need to adjust the placement of diffusers and/or air-pressure in individual diffusers.
3	Maintenance of diffusers	Simulate a service cycle on sample diffusers (select the most remote elements): <ul style="list-style-type: none"> <li>• Easy to isolate from the rest of the system</li> <li>• Easy to retrieve the chosen element</li> <li>• Easy to dismantle the element without disturbing the other plumbing.</li> <li>• Easy to clean the element</li> <li>• Easy to lower it back at the exact spot</li> </ul>	T	Maintenance of diffusers should not disrupt the STP functioning.
4	Membrane type diffuser	Pull out and check if membranes are in good condition	V	
5	Split aeration tank	Easy to isolate and empty EACH tank for repairs <ul style="list-style-type: none"> <li>• Cut off compressed air</li> <li>• (Check safety function)</li> <li>• Equal flow of sewage and recycle sludge to each compartment</li> </ul>	V	
6	Biomass in Aeration tank	<ol style="list-style-type: none"> <li>1. Healthy brown biomass</li> <li>2. Check MLSS level in Aeration tank</li> </ol>	V T	

## Secondary settling tank (Hopper-bottom)

**Note:**

Based on the STP design, select this table (for non-mechanized settling tank) or the next table (for mechanized clarifier tank).

Sl.	Check	Acceptance Criteria	Method	Rationale
1	Settling of sludge	<ul style="list-style-type: none"> <li>Sludge settles without vortex</li> <li>No sludge drawn up near the weir</li> <li>No significant sludge trace in the launders</li> <li>No clumps/ balls of rising sludge</li> </ul>	V	
2	Fine mesh basket at outlet	<ul style="list-style-type: none"> <li>Easy to service the mesh:</li> <li>Easy to remove</li> <li>Easy to clean</li> <li>Easy to fit it in place</li> </ul>	T	

## Secondary Clarifier tank (mechanized, with Rotating Rake)

**Note:**

Based on the STP design, select the previous table (for non-mechanized settling tank) or this table (for mechanized clarifier tank).

Sl.	Check	Acceptance Criteria	Method	Rationale
1	Settling of sludge	<ul style="list-style-type: none"> <li>Sludge settles without vortex</li> <li>No sludge drawn up near the weir</li> <li>No significant sludge trace in the launders</li> <li>No clumps/ balls of rising sludge</li> </ul>	V	
2	Fine mesh basket at outlet	<ul style="list-style-type: none"> <li>Easy to service the mesh:</li> <li>Easy to remove</li> <li>Easy to clean</li> <li>Easy to fit it in place</li> </ul>	T	

3	Bridge	<ul style="list-style-type: none"> <li>Bridge allows safe travel up to motor and gear box.</li> <li>The safety railing has closely spaced balusters to prevent accidental fall from under the railing.</li> </ul>	T	
4	Maintenance of motor and gearbox	Simulate a repair cycle for the motor and gearbox <ul style="list-style-type: none"> <li>Safe access to the motor and gearbox</li> <li>Allows safe removal of motor and gearbox</li> <li>Allows safe carrying of parts out of tank</li> <li>Allows safe re-fitting of parts</li> <li>Check rotational speed of rake</li> </ul>	T  M	If the motor and gear box cannot be made functional within 30 minutes, the bacteria may start dying.
5	Weir level	Check for uniform overflow of water over the entire length of the weir(s)	T	

## Sludge Recirculation pumps-Airlift

**Note:**

Based on the STP design, select this table (for an airlift pump) or the next table (for electric pumps used in **direct-suction** or **buffer sump** variations)

Sl.	Check	Acceptance Criteria	Method	Rationale
1	Air lift	Check if recirculation sludge flow is roughly between 60 -100 % of sewage inflow	V	

## Sludge Recirculation pumps-Electric

**Note:**

Based on the STP design, select the previous table (for an airlift pump) or this table (for electric pumps used in **direct-suction** or **buffer sump** variations)

Sl.	Check	Acceptance Criteria	Method	Rationale
1	Air lift	Check if recirculation sludge flow is roughly between 60 -100 % of sewage inflow	V	

## Sludge Recirculation system-Direct suction

Sl.	Check	Acceptance Criteria	Method	Rationale
1		There are no additional checks. (See the requirements above.)		

## Sludge Recirculation system- With a buffer sump

Sl.	Check	Acceptance Criteria	Method	Rationale
1	Aeration and mixing in sludge sump	<ul style="list-style-type: none"> <li>Bubbles rise across the entire surface (no dead zone in any area, especially edges and corners)</li> <li>There is no odor</li> </ul>	V	This means the system does not pose a threat to the bacteria.
2	Maintenance of pump	Simulate a repair cycle (select the pump that is more difficult to access): <ul style="list-style-type: none"> <li>Easy to cut off from the rest of the system</li> <li>Easy to remove</li> <li>Easy to carry outside STP</li> <li>Easy to assemble back.</li> <li>Check if recirculation sludge flow is roughly between 60 -100 % of sewage inflow</li> </ul>		Although availability of a standby drastically reduces the risk, it should be easy (and fast) to repair a defective pump.

## Clarified water tank

Sl.	Check	Acceptance Criteria	Method	Rationale
1	Aeration and mixing	Bubbles rise across the entire surface (no dead zone in any area, especially edges and corners) <ul style="list-style-type: none"> <li>There is no odor</li> <li>No accumulation of solids in the tank</li> </ul>	V	

## Filter feed Pumps

Sl.	Check	Acceptance Criteria	Method	Rationale
1	Maintenance of pump	Simulate a repair cycle (select the pump that is more difficult to access): <ul style="list-style-type: none"> <li>Easy to cut off from the rest of the system</li> <li>Easy to remove</li> <li>Easy to carry outside STP</li> <li>Easy to assemble back.</li> </ul>	T	

## Backwash pumps

**Note:**

*This table is applicable only when the design uses a separate set of pumps for backwash (not by reversing the flow of the filter-feed pumps)*

Sl.	Check	Acceptance Criteria	Method	Rationale
1	Maintenance of pump	Simulate a repair cycle (select the pump that is more difficult to access): <ul style="list-style-type: none"> <li>Easy to cut off from the rest of the system</li> <li>Easy to remove</li> <li>Easy to carry outside STP</li> <li>Easy to assemble back.</li> </ul>	T	

## Pressure Sand Filter

Sl.	Check	Acceptance Criteria	Method	Rationale
1	Filter operation	Filter is able to handle design flow of water without excessive pressure drop	T	
2	Filter Backwash	Backwash filter for 5-10 minutes and check if initially lot of solids come out, gradually becoming clearer and finally clear water is observed.	T	

## Activated Carbon filter

Sl.	Check	Acceptance Criteria	Method	Rationale
1	Filter operation	Get analysis reports and compare quality at inlet to filter and outlet of filter	T Analysis	
2	Filter Backwash	Backwash filter for 5 minutes and check if initially lot of solids come out, gradually becoming clearer and finally clear water is observed.	T	

## Disinfection system

Sl.	Check	Acceptance Criteria	Method	Rationale
1	Hypo dosing	Check Residual chlorine level with test kit Must be more than 1 PPM after 30 minutes of standing	T	

## Sludge-Handling system

Sl.	Check	Acceptance Criteria	Method	Rationale
1	Filter press operation	Run an entire sludge dewatering cycle of one batch, and check quantity (weight) of sludge cake produced	T	

## Air Blowers

Sl.	Check	Acceptance Criteria	Method	Rationale
1	Noise	Measure the noise. Results close to 80+ dB(A) indicate corrective measures are needed.	T	
2	Capacity	Check if air in sufficient quantity is delivered to all connected tanks simultaneously, as visual indications for each tank as described above	T	

## MISC

Sl.	Check	Acceptance Criteria	Method	Rationale
1	Pressure Gauges	Check all gauges for calibration. <ul style="list-style-type: none"> <li>Preferable to have colored bands for OK/ Not OK conditions</li> <li>Compare each gauge against the limits given in the operating chart</li> </ul>	T	
2	Exhaust/ Ventilation System if in basement room	There must not be any odor or fumes in the STP. Check for tell-tale signs of premature/ excessive rusting of metal parts such as hand-rails, etc.	V	
3	Drainage	Open the drain plug of all tanks (one by one). Turn on the drain pit motor. <ul style="list-style-type: none"> <li>The ground clearance must be sufficient to open the plugs easily.</li> <li>Check if the sewage under pressure is contained in drain or spills out on electrical parts.</li> <li>Check if the drains and the drain pit and motor can handle the volume.</li> </ul>	T	
4	Documentation	Verify the manuals vis-à-vis the actual STP	D	
5	Acoustic isolation	The noise as measured outside STP at the nearest public area must not be more than 55 dB(A) (during day) and 45 dB(A) (during night).	M	
6	DG Operation	Switch to DG from Mains and check if all critical motors can be operated simultaneously	T	
7	Quality of Treated Water	Sample for analysis in a NABL-approved Laboratory	T	

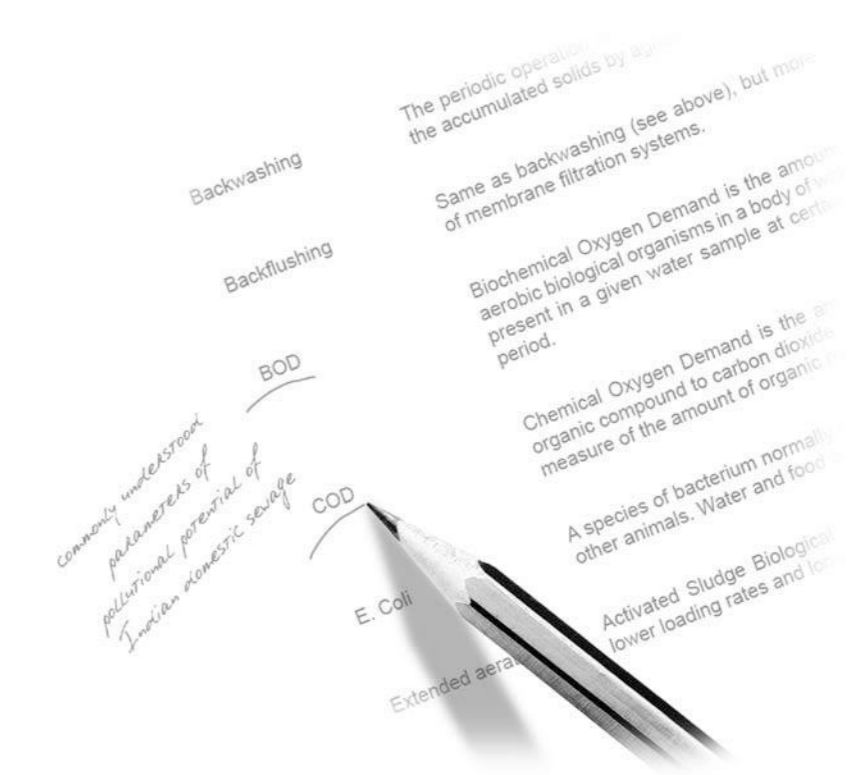

# Appendices

# Managing the Microbes

The desired median age of microbes to be maintained in the system is 25-30 days, because they can digest the sewage at the maximum rate at the age of 25-30 days, as shown below.

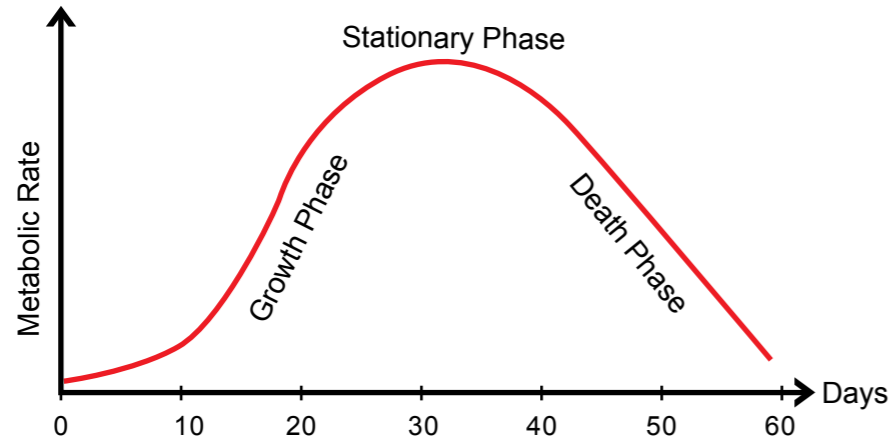

However, the sewage remains for less than 20 hours in aeration tank and settling tank.

Microbes are much like humans in their metabolic activities, although they are life forms that are orders of magnitude lower than an average human being. They feed on the pollutants (= food) present in the wastewater: They require Oxygen (from the air pumped into the aeration tank) for their respiration. They need vitamins and minerals in the form of nutrients such as Nitrogen and Phosphorus (already present in abundance in domestic sewage), and a whole lot of other elements at nano levels for their health and well being, to grow and to multiply.

Any imbalance in even one of the above ingredients in the recipe (Population density, Food, Oxygen, or Nutrients) will render the process extremely vulnerable to failure. Indeed, Microbes are much more sensitive to the slightest of environmental disturbances than humans.

The basic biochemical reaction occurring in an Aeration tank may be summarized by the following simplistic equation:

Microbes + Pollutants (food) + O<sub>2</sub> → More microbes + CO<sub>2</sub> + H<sub>2</sub>O + energy release + byproducts

A typical growth reaction with a number of other products, the most important of which is Carbon Dioxide:

- Accumulated Carbon Dioxide gets converted to Carbonic acid and corrodes metallic parts in the STP.
- The carbonic acid also depresses the pH of the wastewater, thus affecting treatment performance

# MLSS

MLSS (Mixed Liquor Suspended Solids) is a measure of bacteria that is contained in the aeration tank.

In the strict sense, MLSS is a gravimetric unit – mg/L and the normal design level is between 3500 to 4000 mg/L in the Aeration Tank. However, in the field, since the operator does not have ready access to an electronic weighing machine, we do a volumetric measurement using a 1 liter measuring cylinder (or jar).

Take one liter of the Aeration Tank sample (The Mixed Liquor) and allow to settle in the jar for 30 minutes. At the end of the 30 minutes, measure the volume occupied by the settled sludge. If it is 350 mL, we take the MLSS to be 3500 mg/L. If it is 400 mL, the take MLSS to be 4000 mg/L.

The assumption here is that the STP is functioning normally, and therefore the so-called “Sludge Volume Index – SVI) is 100, meaning dry solids weighing 1 gram occupy 100 mL volume after 30 minutes of settling. And so, 4 gram of microbes (4000 mg) will occupy 400 mL volume in the cylinder.

The STP is operated within a band of say 3500 mg/L (350 mL) and 4500 mg/L (450 mL). When the MLSS exceeds 450 mL, the excess sludge is taken out of the system to bring the MLSS down to the say 350 mL, and the process continues until the sludge again builds up to 450 mL.

Normally STP should be operated in a smaller band within the allowable MLSS limits.

MLSS level can be less than the design level only under the following conditions :

1. The STP is in the start-up phase
2. STP design and engineering is poor, so sludge is slipping out of the system
3. STP operation is poor
4. There has been a sudden shock to the STP ( pH drop/ toxic elements etc.)

# Glossary

---

Term	Meaning
Backwashing	The periodic operation in a filter, where flow of water is reversed to flush out the accumulated solids by agitating and fluidizing the filter media.
Backflushing	Same as backwashing (see above), but more commonly used in the context of membrane filtration systems.
BOD	Biochemical Oxygen Demand is the amount of dissolved oxygen needed by aerobic biological organisms in a body of water to break down organic material present in a given water sample at certain temperature over a specific time period.
COD	Chemical Oxygen Demand is the amount of oxygen required to oxidize an organic compound to carbon dioxide, ammonia, and water. This is an indirect measure of the amount of organic pollutants found in water.
E. Coli	A species of bacterium normally present in the intestinal tract of humans and other animals. Water and food contaminated with it may cause diseases.
Extended aeration	Activated Sludge Biological system operating at low F/M ratio, resulting in lower loading rates and longer retention times in the aeration tank
F/M	The Food/ Microorganisms ratio, which is to be set for a given STP. It can be in the range 0.05 to 0.40 (5% to 40%).
Freeboard	Distance in a closed tank from the sewage level to the top of the tank.
MLSS	The contents/ mixture in the aeration tank is called Mixed Liquor. The suspended solids in this Mixed Liquor is called MLSS ( which is taken to be the microbes).
O&G	Oil and grease

pH	A measurement that indicates the acidity or alkalinity of any solution. Acidic solutions have a pH<7; and alkaline solutions have a pH>7) Solutions with pH=7 are neutral.
Treatment efficiency	Percentage removal of any pollutant parameter in the STP.
TSS	Total Suspended Solids
Clarifier tank	A term generally used for a mechanically raked sedimentation tank. Depending on the placement in the STP, the clarifier tank is qualified as follows:
Primary Clarifier	Clarifier used ahead of the Aeration tank
Secondary Clarifier	Clarifier used following the Aeration tank
Tertiary Clarifier	Clarifier used following the secondary clarifier tank
Settling tank	A term generally used for an unmechanized, hopper-bottom sedimentation tank

---



# About the Author

---

Dr. Ananth S. Kodavasal is an environmental expert, with a B. Tech in Chemical Engineering at IIT Madras and M.S. and PhD from Vanderbilt University, Nashville, USA.

His interest in environmental engineering was awakened when he had the great fortune to be mentored by the legendary professor Wesley Eckenfelder at the Vanderbilt University, who happens to be the author of the first textbooks in the field of environmental engineering.

This interest led him to choose the subject of *Computer Modeling And Simulation Of Non Linear Adsorption Kinetics on Activated Carbon for Advanced Wastewater Treatment* for his doctoral dissertation.

After returning to India, he set up his own company, Ecotech Engineering Consultancy Private Limited, that has over 500 clients in India and abroad for various services, such as water resources management, wastewater management, treatability studies, operation & maintenance services, eco management and audit systems, professional development programs and upgradation of treatment plants.

He is a keen environmentalist, and spends a large part of his personal time in evangelizing with public about the scientific methods of water resource management. He is also concerned about the worsening water scenario in India, and believes that with proper public guidance and improved laws, the situation can be salvaged to a large extent. He has carried out several campaigns on this subject, and even this book is an extension of that effort.

In his spare time, he likes to relax with his beloved family, and pet golden retriever, Toffee.

## **The STP Guide**

Released by Karnataka State Pollution Control Board  
on the occasion of **Board Formation Day,**  
**21<sup>st</sup> September 2011**

No. of Copies: 1500

₹200

Year of 1<sup>st</sup> Edition: 2011



**Karnataka State Pollution Control Board**

**ಕರ್ನಾಟಕ ರಾಜ್ಯ ಮಾಲಿನ್ಯ ನಿಯಂತ್ರಣ ಮಂಡಳಿ**

"Parisara Bhavan", #49, Church Street, Bangalore – 560 001

Website: <http://kspcb.gov.in>

E-mail: [ho@kspcb.gov.in](mailto:ho@kspcb.gov.in)